

ezpeleta<sup>e</sup>



CONTRACT 2024





# Contents

**06**

Sillas, Cadeiras, Chairs, Chaises.

**60**

Mesas, Tables.

**80**

Lounge.

**100**

Separadores, Space dividers, Séparateurs.

**104**

Parasoles, Guarda-sóis, Parasols.

**186**

Bases, Pietements.

**127**

Detalles técnicos, Detalhes técnicos, Technical details, Détails techniques.

# TRENA

*by Yonoh Studio*



TRENA CHAIR - soft pink  
MONACO - sand-oak



TRENA STOOL - pearl  
TRENA ARMCHAIR - taupe  
TRENA CHAIR - soft pink



TRENA CHAIR - soft pink  
MONACO - sand-oak



TRENA - pearl



TRENA STOOL - blue grey  
 TRENA CHAIR - pearl  
 TRENA ARMCHAIR - blue grey  
 QUATRO FOLD - anthracite-black marble

QUATRO HIGH FIX - anthracite-white marble  
 EOLO - white-mineral blue  
 BOND - white

# NOON

*by Héctor Serrano*



NOON - taupe  
QUATRO FOLD - sand-taupe



NOON - blue grey, pearl



NOON - blue grey, pearl  
RODAS - taupe-taupe



NOON - terracota  
QUATRO FOLD - sand-taupe  
QUATRO DUO - sand-taupe



# BAKE WOOD



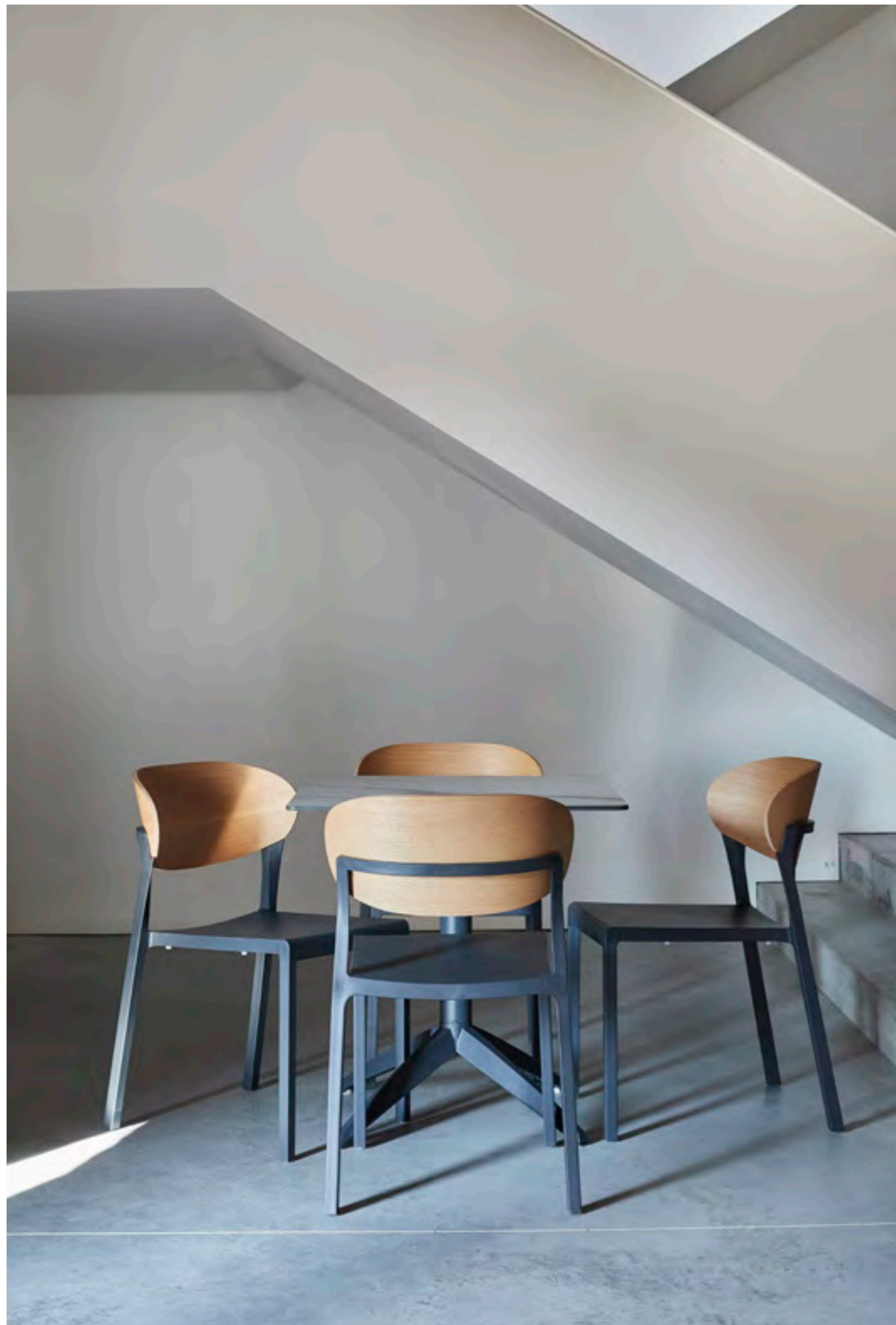

**BAKEWOOD** - anthracite  
**QUATROFIX** - anthracite-white marble



**BAKEWOOD PAD** - sand-pad taupe  
**QUATROFOLD** - sand-taupe

# BAKE

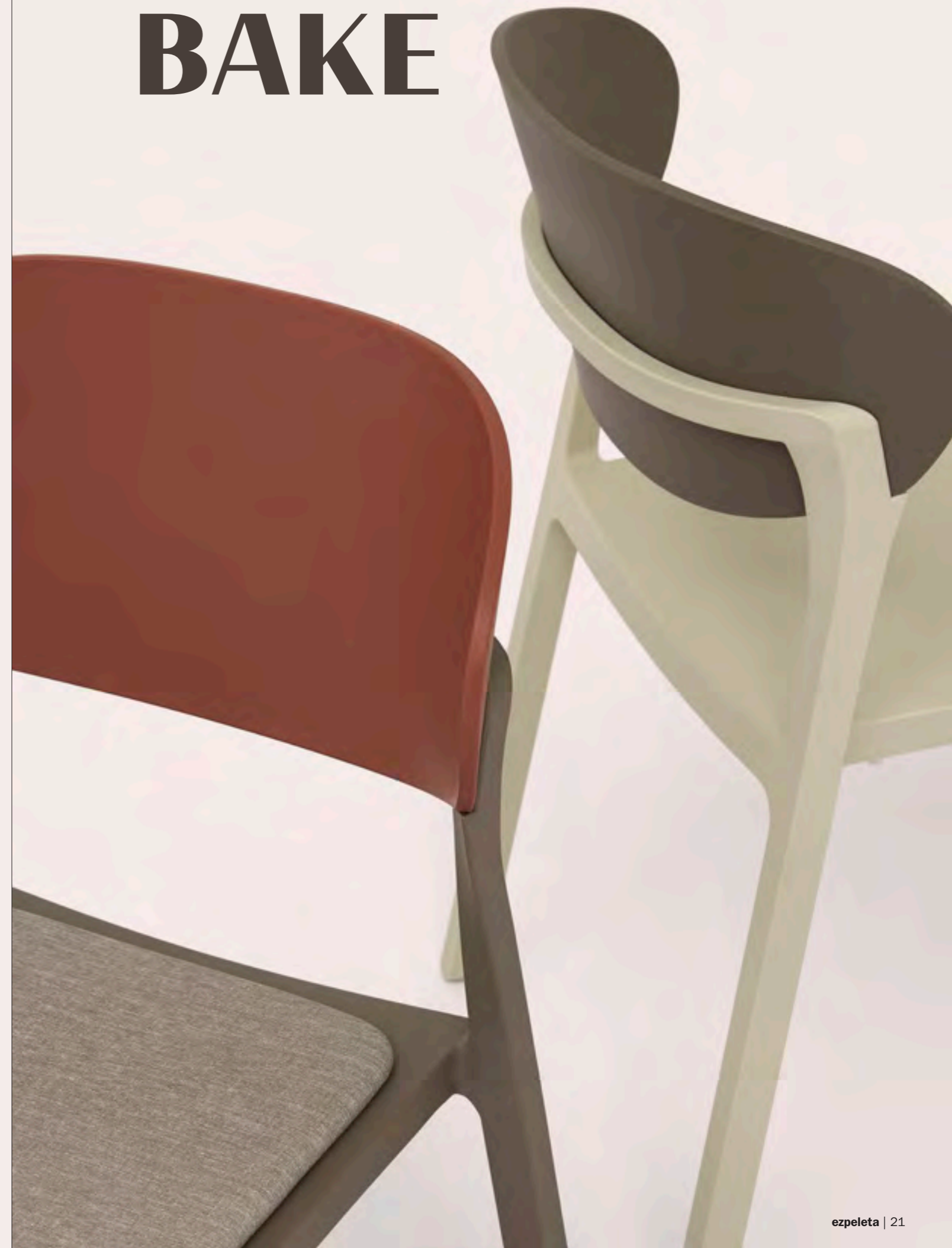



BAKE - taupe-terracota  
MONACO - taupe-dark oak



BAKE - olivo-pearl  
MONACO - taupe-oak



**ROD**



**ROD PAD** - taupe-terracota pad taupe, taupe-taupe pad taupe  
**MEET** - taupe-oak



**ROD** - anthracite-blue grey  
**MEET** - anthracite - dark oak

# HOP





HOP - olivo, taupe  
ATTIC - olivo, taupe  
MONACO - taupe-oak  
QUATRO HIGH FIX - taupe-oak



# FADO



FADO - olivo, aquamarine, mustard  
MONACO - taupe-taupe



FADO - sand, aquamarine  
MONACO - white-white



FADO - sand, taupe  
QUATROFOLD - taupe-oak

# ATTIC



ATTIC - aquamarine



ATTIC - taupe  
QUATRO HIGH FIX - taupe-taupe



ATTIC - brick  
URBAN - anthracite-anthracite



ATTIC - aquamarine, mustard  
URBAN - taupe-white marble

# TOWN



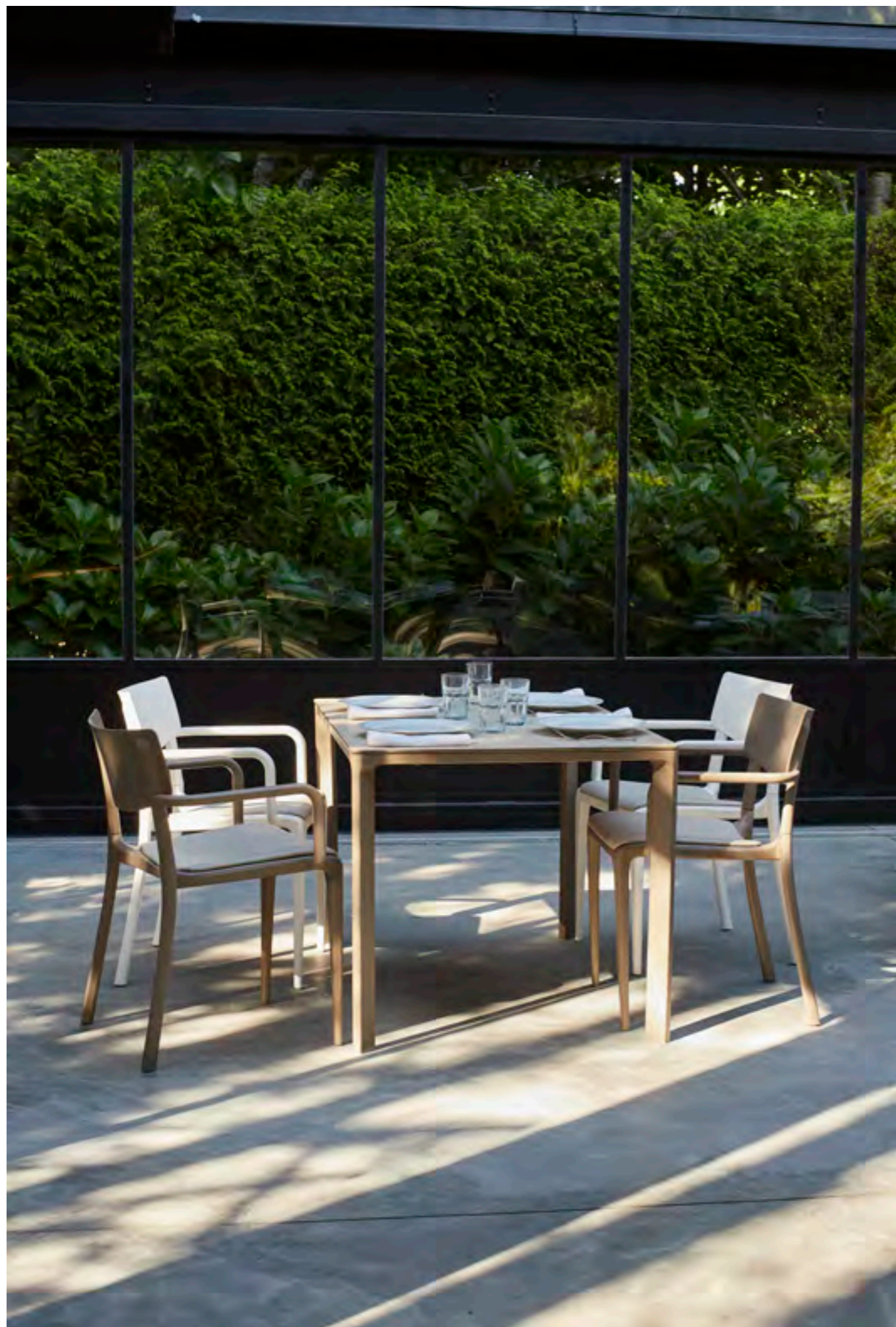

**TOWN PAD** - white-pad taupe, taupe-pad taupe  
**MEET** - taupe-oak



**TOWN** - mustard, taupe  
**KOS** - white-white

# PARK





**PARK** - ocean  
**ONE** - anthracite-anthracite



**PARK** - white  
**ATTIC** - white  
**MONACO** - white-oak  
**URBAN** - white-oak





**DOCK**



DOCK - white  
MONACO - white-oak



DOCK - taupe  
MEET - anthracite-taupe  
RIO - white  
FASTCLICKRIO

# LAND



LAND - white  
QUATRO FOLD - white-white  
PALMA - white



LAND - anthracite  
MONACO - anthracite-white marble



LAND - taupe  
QUATRO FIX - white-white  
FLEXXO - white-taupe  
KIT FLEXXO - white

# MONACO & SICILIA





SICILIA - white  
MONACO - white-dark oak



MONACO - sand, taupe  
MONACO - white-white



**MEET**



MEET - white-white  
TRENA CHAIR - soft pink, pearl, blue grey  
TRENA ARMCHAIR - taupe



# MONACO & URBAN





**MONACO** - white - black marble  
**LAND** - white  
**FLEXO** - white-anthracite stripe  
**SLAB** - white



**URBAN** - anthracite - dark oak  
**ATTIC** - taupe



# QUATRO

*duo fix, fold, fix and high fix*



QUATRO DUO - sand-taupe  
BAKE - sand-taupe  
EOLO - taupe-vintage pink  
BOND - taupe

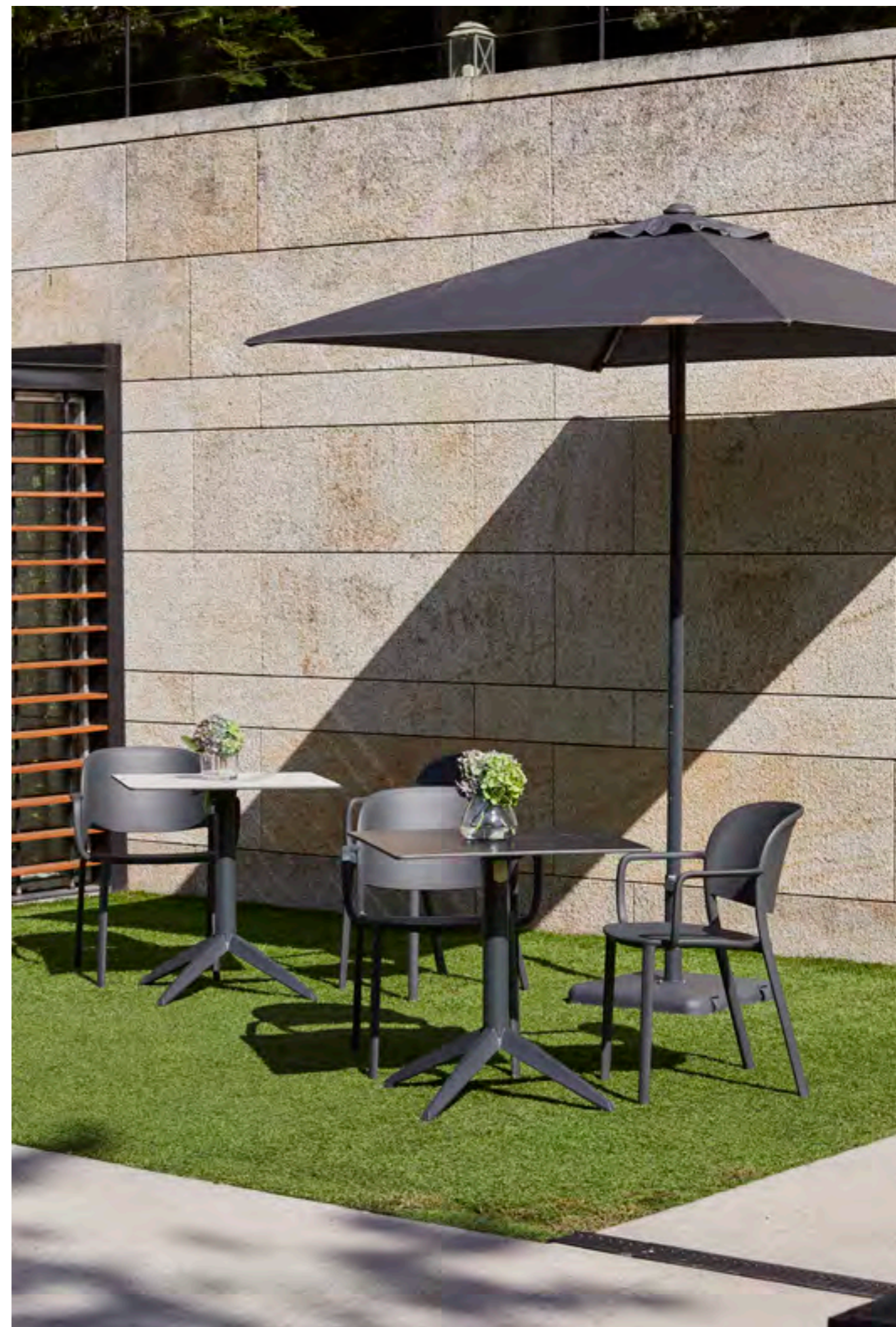

QUATRO FOLD - anthracite-black marble, anthracite-white marble  
TRENA - anthracite  
EOLO PURETI - anthracite  
BOND - anthracite

# ONE





ONE - white-white  
FADO - aquamarine, sand  
VIGO - white  
FLAT - grey



ONE - taupe-taupe  
TOWN - taupe

# KOS & RODAS





**RODAS** - taupe-taupe  
**DOCK** - brick, taupe



**KOS** - anthracite-black marble  
**SICILIA** - anthracite





# LAGO





LAGO - taupe-olivo, white  
 VILA - taupe  
 MARINE - white  
 EOLOPURETI - white



LAGO - taupe  
 VILA - taupe  
 EOLOPURETI - taupe-sand  
 BOND - taupe



**VILA**

VILA - taupe-olivo  
JAVA - white  
VILA - taupe



VILA - white-taupe  
EOLO - taupe-white  
VILA - taupe  
FLAT - taupe



VILA - anthracite  
VILA - anthracite

# AQUA & NAUTIC





VILA - taupe  
AQUA - beige



VILA ARMS - taupe  
NAUTIC - taupe  
VILA - taupe

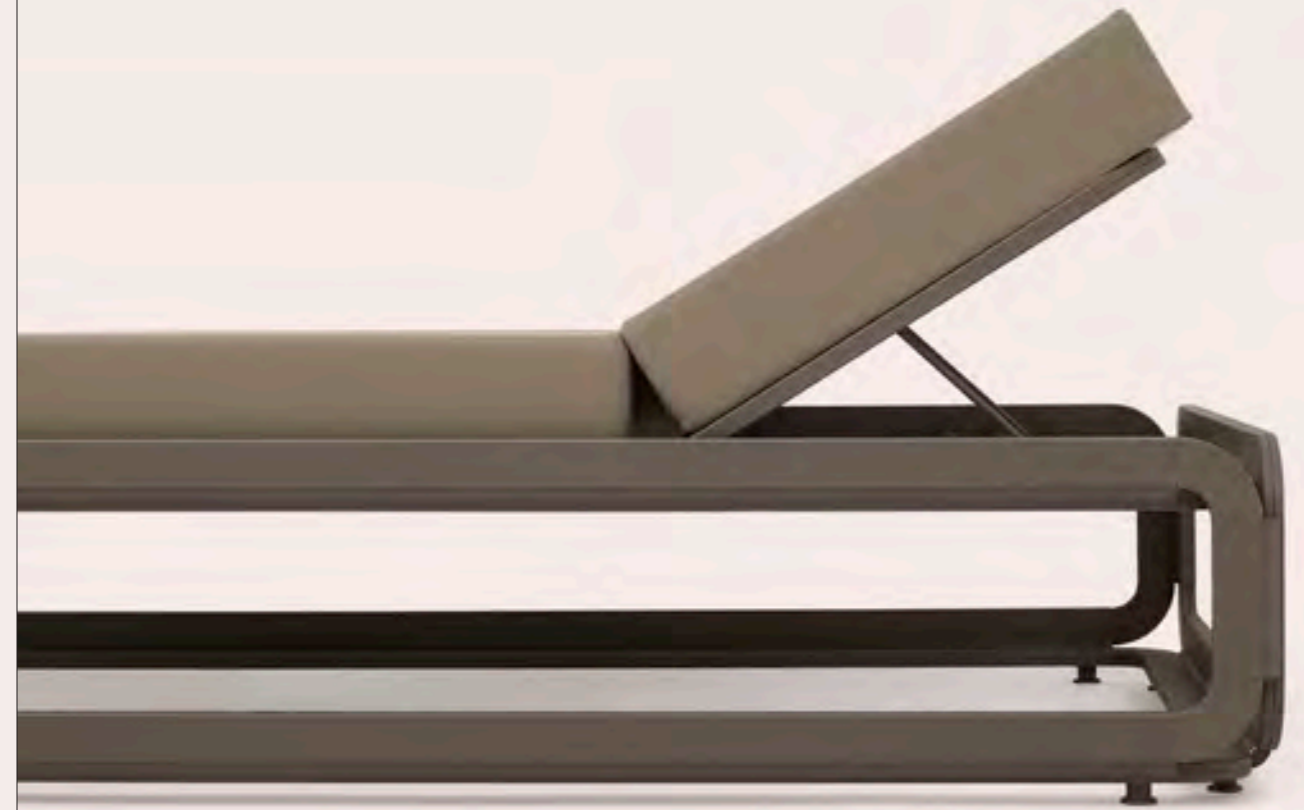

# IBIZA & NANA

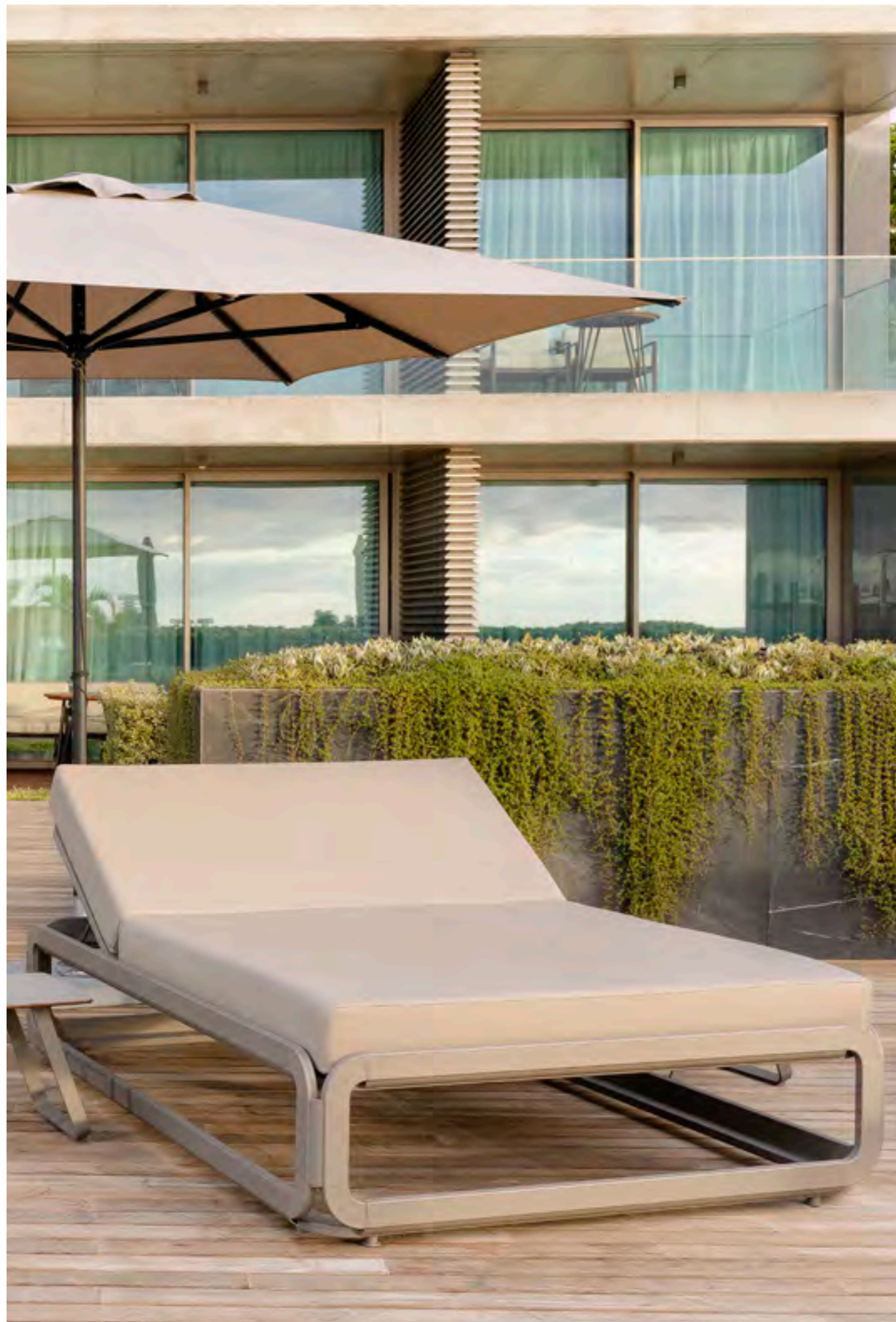

**NANA** - taupe  
**VILA** - taupe  
**FORMENTERA** - anthracite-taupe



**IBIZA** - white





# MARINE





MARINE - white  
MARINE - white compact

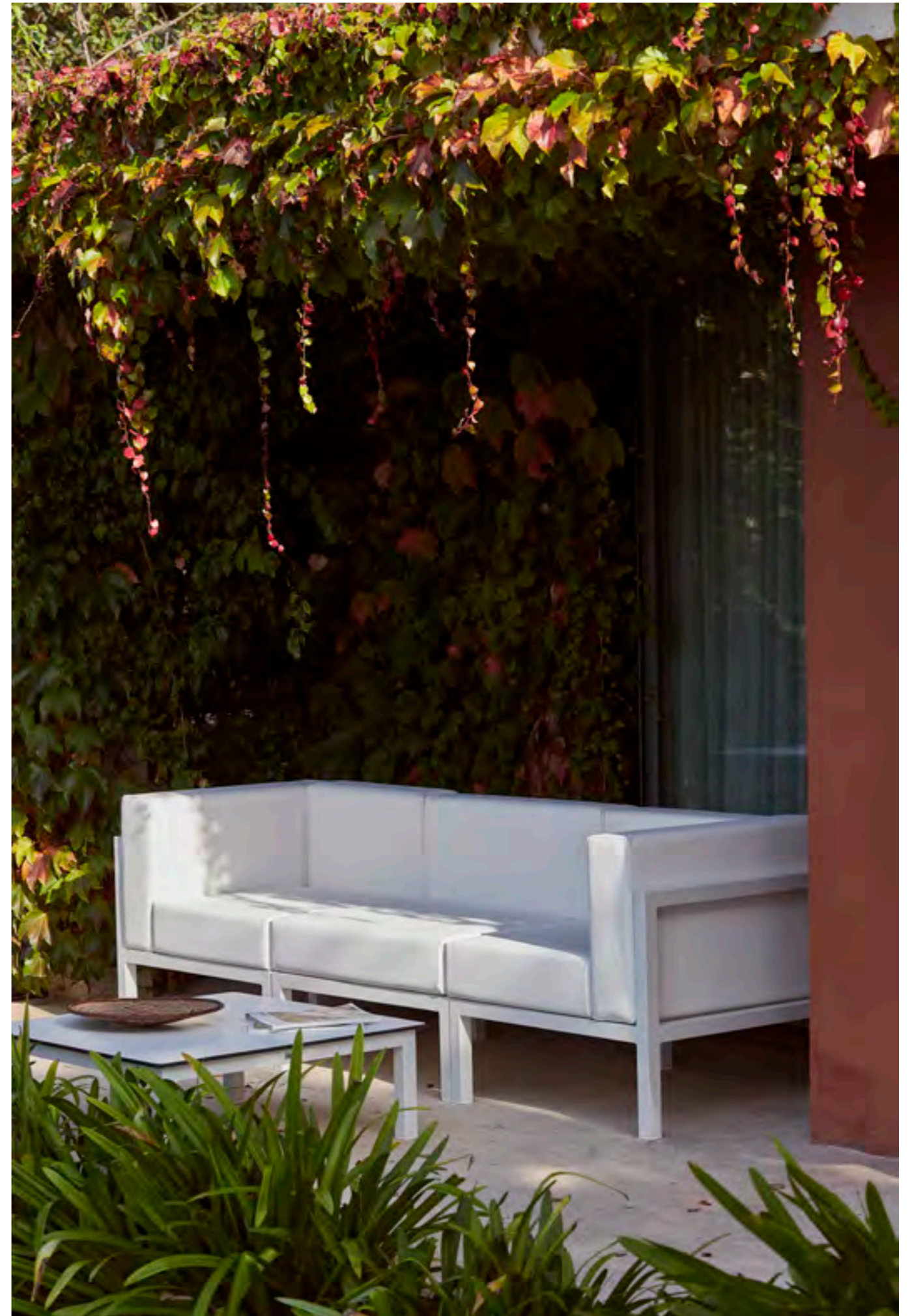

MARINE - white  
MARINE - white compact



# SIENA



SIBARITA

BAR & SHOP  
- VIGO -



SIENA - anthracite  
JARDINERA - black  
ROD - anthracite-anthracite  
ATTIC - brick

# PARASOLS



# EOLO PURETI





**EOLo** - taupe-sand  
**LAGO** - taupe, white  
**VILA** - taupe, white  
**ROUND** - taupe



# EOLo

**EOLo** - taupe - vintage pink  
**EOLo** - white - mineral blue  
**EOLo** - anthracite - marble  
**BOND** - anthracite - taupe - white



**FLEXO**

FLEXO - white - anthracite stripe  
SLAB - white  
LAND - white  
MONACO - white - black marble



# RIO



# FORMENTERA



FORMENTERA - anthracite-taupe  
FAST CLICK

# VIGO



VIGO - white  
FADO - sand, aquamarine  
MONACO - white-white



**JAVA**

JAVA - white  
VILA - taupe-olivo  
VILA - taupe  
BOND - taupe



# MADEIRA

MADEIRA - blue stripe  
CANTO - rust  
TRENA - taupe  
URBAN - taupe - dark oak



# FARO

FARO - white  
DOCK - white  
QUATRO FIX - moka-white



# PALMA

PALMA - white  
VILA - white  
VILA - white



# MENORCA

MENORCA - olivo  
TRENA - pearl  
QUATRO HIGH FIX - taupe-taupe  
BOND - white

# TENERIFE



TENERIFE - white  
FIT - white  
BAKE - anthracite-blue grey  
QUATRO FOLD - anthracite-anthracite

# MANILA



RODAS - taupe-oak  
ROD - sand-cappuchino  
MANILA  
FIT - rust



**NEWTOSCANA** - olivo-sand  
**NOON** - taupe  
**QUATRO FOLD** - taupe-taupe  
**FIT** - white



# NEW TOSCANA

**NEWTOSCANA** - sand  
**TRENA** - terracota  
**QUATRO FOLD** - taupe-taupe  
**FIT** - white

# ONS



## Detalles Técnicos Detalhes Técnicos Technical Details Détails Techniques



apilable - empilhável - stackable - empilable



uso interior - indoor use - pour l'intérieur



protección UV - proteção UV - UV protection - protection UV



uso exterior - outdoor use - utilisation en extérieur



abatible - rebatível - folding - pliante



apilable - empilhável - stackable - empilable



reguladores de altura - adjustable leveling feet - vérins réglables



desenfundable - removível - removable - déhoussable



reciclable - reciclável - recyclable



resistente al moho - resistente ao bolor - mold resistant - résistant à la moisissure



muy fácil de lavar y desinfectar - muito fácil de lavar e desinfetar - very easy to clean up and disinfect - très facile à laver et à désinfecter



fabricado en la Unión Europea - feito na União Europeia - made in the European Union - fabriqué dans l'union européenne



## TRENA ARMCHAIR

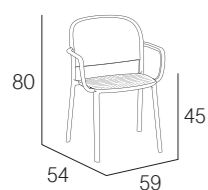

MN-TRE00  
091X00 anthracite



MN-TRE00  
024X00 taupe



MN-TRE00  
026X00 terracota



MN-TRE00  
029X00 blue grey



MN-TRE00  
011X00 soft pink



MN-TRE00  
028X00 pearl

NEW

Sillón apilable. Polipropileno reforzado con fibra de vidrio.  
Inyección por gas. Tacos antideslizantes.  
*Cadeira empilhável. Polipropileno reforçado com fibra de vidro.  
Injeção por gás. Tacos antiderrapantes.*  
Stackable armchair. Fiberglass reinforced polypropylene. Gas  
injection. Non slip caps.  
*Fauteuil empilable. Polypropylène renforcé avec fibre de verre.  
Injection par gaz. Embouts antidérapants.*

Registered design No. 015018296-0002



UE



## TRENA CHAIR

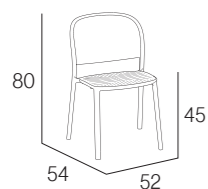

MS-TRE00  
091X00 anthracite



MS-TRE00  
024X00 taupe



MS-TRE00  
026X00 terracota



MS-TRE00  
029X00 blue grey



MS-TRE00  
011X00 soft pink



MS-TRE00  
028X00 pearl

NEW

Silla apilable. Polipropileno reforzado con fibra de vidrio.  
Inyección por gas. Tacos antideslizantes.  
*Cadeira empilhável. Polipropileno reforçado com fibra de vidro.  
Injeção por gás. Tacos antiderrapantes.*  
Stackable chair. Fiberglass reinforced polypropylene. Gas  
injection. Non slip caps.  
*Chaise empilable. Polypropylène renforcé avec fibre de verre.  
Injection par gaz. Embouts antidérapants.*

Registered design No. 015018296-0001



UE



## TRENA STOOL

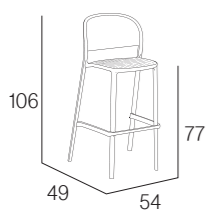

MT-TRE00  
091X00 anthracite



MT-TRE00  
024X00 taupe



MT-TRE00  
026X00 terracota



MT-TRE00  
029X00 blue grey



MT-TRE00  
011X00 soft pink



MT-TRE00  
028X00 pearl

NEW

Taburete apilable. Polipropileno reforzado con fibra de vidrio.  
Inyección por gas. Tacos antideslizantes.  
*Banco alto empilhável. Polipropileno reforçado com fibra de  
vidro. Injeção por gás. Tacos antiderrapantes.*  
Stackable stool. Fiberglass reinforced polypropylene. Gas  
injection. Non slip caps.  
*Tabouret empilable. Polypropylène renforcé avec fibre de verre.  
Injection par gaz. Embouts antidérapants.*

Registered design No. 015018296-0003



UE



**Trena Collection**  
by Yonoh Studio

# NOON

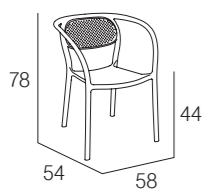

MN-NON00  
024X00 taupe



MN-NON00  
028X00 pearl



MN-NON00  
026X00 terracota



MN-NON00  
029X00 blue grey

NEW

Sillón apilable. Polipropileno reforzado con fibra de vidrio.  
Inyección por gas. Tacos antideslizantes.  
*Cadeira empilhável. Polipropileno reforçado com fibra de vidro.  
Injeção por gás. Tacos antiderrapantes.*  
Stackable armchair. Fiberglass reinforced polypropylene. Gas  
injection. Non slip caps.  
*Fauteuil empilable. Polypropylène renforcé avec fibre de verre.  
Injection par gaz. Embouts antidérapants.*

Registered design No. 015020798-0001

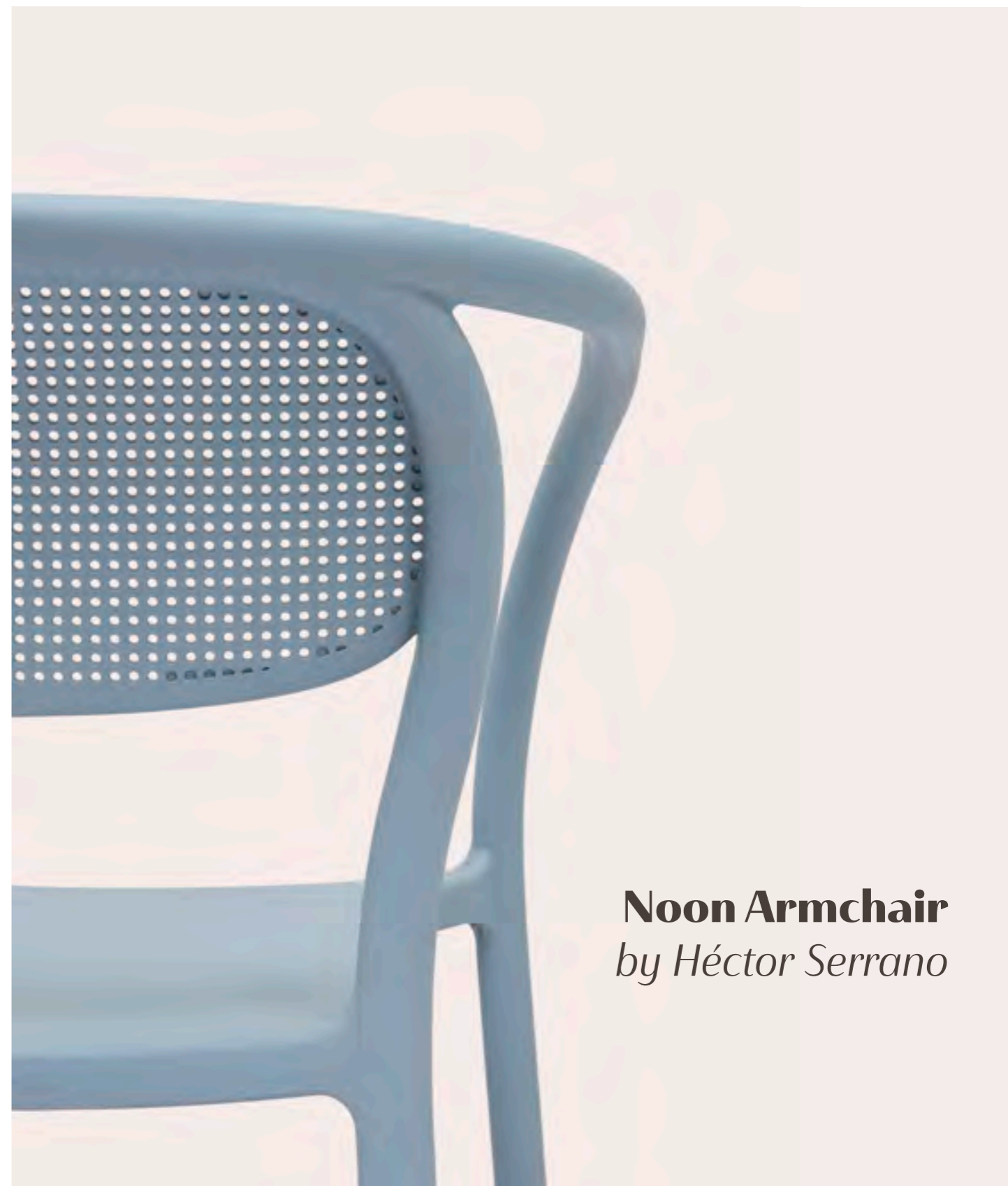

**Noon Armchair**  
*by Héctor Serrano*

## BAKE WOOD

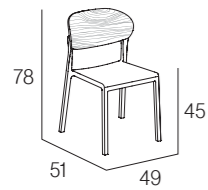

MS-BAK20  
024X00 taupe



MS-BAK20  
071X00 sand



MS-BAK20  
091X00 anthracite



MS-BAK20  
066X00 olivo

## BAKE WOOD PAD

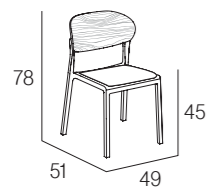

MS-BAK23  
024X-015S0  
taupe-pad taupe



MS-BAK24  
071X-015S0  
sand-pad taupe



MS-BAK21  
091X-015S0  
anthracite-pad taupe



MS-BAK25  
066X-015S0  
olivo-pad taupe

## BAKE

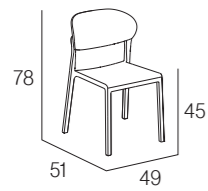

MS-BAK01 anthracite  
029X00 blue grey



MS-BAK04 sand  
024X00 taupe



MS-BAK03 taupe  
026X00 terracota



MS-BAK05 olivo  
028X00 pearl

## BAKE PAD

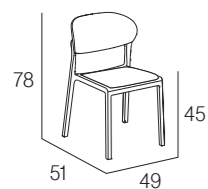

MS-BAK11 anthracite  
029X-015S0  
blue grey-pad taupe



MS-BAK14 sand  
024X-015S0  
taupe-pad taupe



MS-BAK13 taupe  
026X-015S0  
terracota-pad taupe



MS-BAK15 olivo  
028X-015S0  
pearl-pad taupe



Silla apilable. Asiento de polipropileno reforzado con fibra de vidrio (inyección por gas). Respaldo de madera chapada en haya en el interior y roble en la cara exterior, fabricado bajo certificación con colas ULEF. Uso interior. Tacos antideslizantes.

*Cadeira empilhável. Assento em polipropileno reforçado com fibra de vidro (injeção por gás). Encosto em madeira folheada em faia na parte interior e carvalho na parte exterior, fabricado com resinas UF de baixa emissão de formaldeído (ULEF). Uso interior. Tacos antiderrapantes.*

Stackable chair. Fibreglass reinforced polypropylene structure (gas injection). The chair back has a beech plywood inner face and oak outer face, produced using certified ULEF. Non slip caps.

*Chaise empilage. siège en polypropylène renforcé avec de la fibre de verre (injection par gaz). Le dossier en bois de hêtre plaqué sur le côté intérieur et en chêne sur le côté extérieur, fabriqué sous certification avec colles ULEF. Embouts antidérapants.*

Registered design No. 009083025-0001



Silla. Polipropileno reforzado con fibra de vidrio. Inyección por gas. Asiento de polipropileno tapizado (50% vinilo/50% poliéster). Respaldo de madera chapada en haya en el interior y roble en la cara exterior, fabricado bajo certificación con colas ULEF. Uso interior.

*Cadeira. Polipropileno reforçado com fibra de vidro. Injeção por gás. Assento em polipropileno acolchoado (50% vinil/50% poliéster). Encosto em madeira folheada em faia na parte interior e carvalho na parte exterior, fabricado com resinas UF de baixa emissão de formaldeído (ULEF). Uso interior.*

Chair. Fibreglass reinforced polypropylene. Gas injection. Upholstered polypropylene shell seat (50% vinyl/50% polyester). The chair back has a beech plywood inner face and oak outer face, produced using certified ULEF.

*Chaise. Polypropylène renforcé avec fibre de verre. Injection par gaz. Assise tapissée en polypropylène (50% vinil/50% polyester). Le dossier en bois de hêtre plaqué sur le côté intérieur et en chêne sur le côté extérieur, fabriqué sous certification avec colles ULEF.*

Registered design No. 009083025-0001



Silla apilable. Polipropileno reforzado con fibra de vidrio. Inyección por gas. Tacos antideslizantes.

*Cadeira empilhável. Polipropileno reforçado com fibra de vidro. Injeção por gás. Tacos antiderrapantes.*

Stackable chair. Fibreglass reinforced polypropylene. Gas injection. Non slip caps.

*Chaise empilable. Polypropylène renforcé avec fibre de verre. Injection par gaz. Embouts antidérapants.*

Registered design No. 009083025-0001

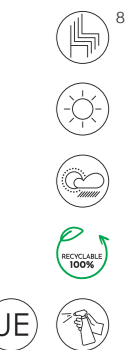

Silla. Polipropileno reforzado con fibra de vidrio. Inyección por gas. Asiento de polipropileno tapizado (50% vinilo/50% poliéster). Uso interior. Tacos antideslizantes. Muy fácil de lavar y desinfectar.

*Cadeira. Polipropileno reforçado com fibra de vidro. Injeção por gás. Assento em polipropileno acolchoado (50% vinil/50% poliéster). Uso interior. Tacos antiderrapantes. Muito fácil de lavar e desinfectar.*

Chair. Fibreglass reinforced polypropylene. Gas injection. Upholstered polypropylene shell seat (50% vinyl/50% polyester). Indoor use. Non slip caps. Very easy to clean up and disinfect.

*Chaise. Polypropylène renforcé avec fibre de verre. Injection par gaz. Assise tapissée en polypropylène (50% vinil/50% polyester). Pour l'intérieur. Embouts antidérapants. Très facile à laver et à désinfecter.*

Registered design No. 009083025-0001



## ROD

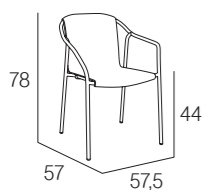

MN-ROD01 anthracite  
091X00 anthracite



MN-ROD01 anthracite  
029X00 blue grey



MN-ROD02 moka  
028X00 pearl



MN-ROD03 taupe  
024X00 taupe



MN-ROD03 taupe  
026X00 terracota



MN-ROD04 sand  
027X00 cappuccino

Sillón apilable. Estructura de aluminio lacado. Asiento de polipropileno. Tacos antideslizantes.  
*Cadeira empilhável. Estrutura em alumínio lacado. Assento em polipropileno. Tacos antiderrapantes.*  
Stackable armchair. Lacquered aluminium frame. Polypropylene shell. Non slip caps.  
*Fauteuil empilable. Structure en aluminium laqué. Assise en polypropylène. Embouts antidérapants.*

Registered design No. 006954285



## ROD PAD

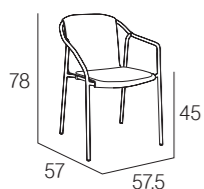

MN-ROD11 anthracite  
091X-013S0  
anthracite-pad grey



MN-ROD11 anthracite  
029X-013S0  
blue grey-pad grey



MN-ROD12 moka  
028X-013S0  
pearl-pad taupe



MN-ROD13 taupe  
024X-013S0  
taupe-pad taupe



MN-ROD13 taupe  
026X-013S0  
terracota-pad taupe



MN-ROD14 sand  
027X-013S0  
cappuccino-pad taupe

Sillón. Estructura de aluminio lacado. Asiento de polipropileno tapizado (50% vinilo/50% poliéster). Uso interior. Tacos antideslizantes. Muy fácil de lavar y desinfectar.  
*Cadeira. Estrutura em alumínio lacado. Assento em polipropileno acolchoado (50% vinil/50% poliéster). Uso interior. Tacos antiderrapantes. Muito fácil de lavar e desinfectar.*

Armchair. Lacquered aluminium frame. Upholstered polypropylene shell seat (50% vinyl/50% polyester). Indoor use. Non slip caps. Very easy to clean up and disinfect.

*Fauteuil. Structure en aluminium laqué. Assise tapissée en polypropylène (50% vinyle/50% polyester). Pour l'intérieur. Embouts antidérapants. Très facile à laver et à désinfecter.*

Registered design No. 006954285



## HOP

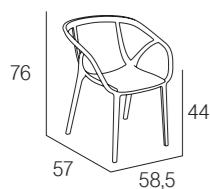

MN-HOP00  
024X00 taupe



MN-HOP00  
026X00 terracota



MN-HOP00  
066X00 olivo

Sillón apilable. Polipropileno reforzado con fibra de vidrio. Inyección por gas. Tacos antideslizantes.

*Cadeira empilhável. Polipropileno reforçado com fibra de vidro. Injeção por gás. Tacos antiderrapantes.*

Stackable armchair. Fiberglass reinforced polypropylene. Gas injection. Non slip caps.

*Fauteuil empilable. Polypropylène renforcé avec fibre de verre. Injection par gaz. Embouts antidérapants.*



## FADO

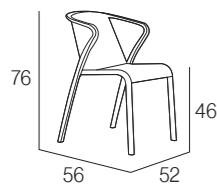

MN-FAD00  
071X00 sand



MN-FAD00  
024X00 taupe



MN-FAD00  
091X00 anthracite



MN-FAD00  
065X00 brick



MN-FAD00  
064X00 mustard



MN-FAD00  
084X00 aquamarine



MN-FAD00  
066X00 olivo

Sillón apilable. Polipropileno reforzado con fibra de vidrio. Inyección por gas. Tacos antideslizantes.

*Cadeira empilhável. Polipropileno reforçado com fibra de vidro. Injeção por gás. Tacos antiderrapantes.*

Stackable armchair. Fiberglass reinforced polypropylene. Gas injection. Non slip caps.

*Fauteuil empilable. Polypropylène renforcé avec fibre de verre. Injection par gaz. Embouts antidérapants.*

Registered design No. 4017226



## ATTIC

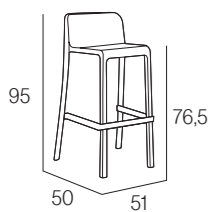

MT-ATT00  
010X00 white



MT-ATT00  
071X00 sand



MT-ATT00  
024X00 taupe



MT-ATT00  
091X00 anthracite



MT-ATT00  
065X00 brick



MT-ATT00  
064X00 mustard



MT-ATT00  
084X00 aquamarine



MT-ATT00  
066X00 olivo

Taburete apilable. Polipropileno reforzado con fibra de vidrio. Inyección por gas. Tacos antideslizantes.

*Banco alto empilhável. Polipropileno reforçado com fibra de vidro. Injeção por gás. Tacos antiderrapantes.*

Stackable stool. Fiberglass reinforced polypropylene. Gas injection. Non slip caps.

*Tabouret empilable. Polypropylène renforcé avec fibre de verre. Injection par gaz. Embouts antidérapants.*

Registered design No. 4016665



## TOWN ARMCHAIR

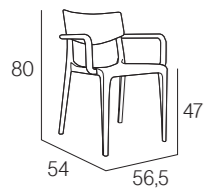

MN-TOW00  
010X00 white



MN-TOW00  
024X00 taupe



MN-TOW00  
091X00 anthracite



MN-TOW00  
065X00 brick



MN-TOW00  
064X00 mustard



MN-TOW00  
066X00 olivo

Sillón apilable. Polipropileno reforzado con fibra de vidrio. Inyección por gas. Tacos antideslizantes.  
Cadeira empilhável. Polipropileno reforçado com fibra de vidro. Injeção por gás. Tacos antiderrapantes.  
Stackable armchair. Fiberglass reinforced polypropylene. Gas injection. Non slip caps.  
Fauteuil empilable. Polypropylène renforcé avec fibre de verre. Injection par gaz. Embouts antidérapants.

Registered design No. 2747774



## TOWN CHAIR

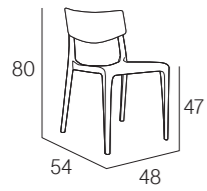

MS-TOW00  
010X00 white



MS-TOW00  
024X00 taupe



MS-TOW00  
091X00 anthracite



MS-TOW00  
065X00 brick



MS-TOW00  
064X00 mustard



MS-TOW00  
066X00 olivo

Silla apilable. Polipropileno reforzado con fibra de vidrio. Inyección por gas. Tacos antideslizantes.  
Cadeira empilhável. Polipropileno reforçado com fibra de vidro. Injeção por gás. Tacos antiderrapantes.  
Stackable chair. Fiberglass reinforced polypropylene. Gas injection. Non slip caps.  
Chaise empilable. Polypropylène renforcé avec fibre de verre. Injection par gaz. Embouts antidérapants.

Registered design No. 2747774



## TOWN ARMCHAIR PAD

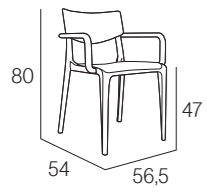

MN-TOW10  
010X - 015S01  
white-taupe



MN-TOW10  
024X - 015S0  
taupe-taupe



MN-TOW10  
091X - 013S0  
anthracite-grey



MN-TOW10  
065X - 015S0  
brick-taupe



MN-TOW10  
064X - 015S0  
mustard-taupe



MN-TOW10  
066X - 013S0  
olivo-grey

Sillón. Polipropileno reforzado con fibra de vidrio. Inyección por gas. Asiento tapizado (50% vinilo/50% poliéster). Uso interior. Tacos antideslizantes. Muy fácil de lavar y desinfectar.  
Cadeira. Polipropileno reforçado com fibra de vidro. Injeção por gás. Assento acolchoado (50% vinil/50% poliéster). Uso interior. Tacos antiderrapantes. Muito fácil de lavar e desinfectar.  
Armchair. Fiberglass reinforced polypropylene. Gas injection. Upholstered seat (50% vinyl/50% polyester). Indoor use. Non slip caps. Very easy to clean up and disinfect.  
Fauteuil. Polypropylene renforcé avec fibre de verre. Injection par gaz. Assise tapissée (50% vinyl/50% polyester). Pour l'intérieur. Embouts antidérapants. Très facile à laver et à désinfecter.

Registered design No. 2747774



## TOWN CHAIR PAD

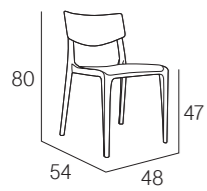

MS-TOW10  
010X - 015S0  
white-taupe



MS-TOW10  
024X - 015S0  
taupe-taupe



MS-TOW10  
091X - 013S0  
anthracite-grey



MS-TOW10  
065X - 015S0  
brick-taupe



MS-TOW10  
064X - 015S0  
mustard-taupe



MS-TOW10  
066X - 013S0  
olivo-grey

Silla. Polipropileno reforzado con fibra de vidrio. Inyección por gas. Asiento tapizado (50% vinilo/50% poliéster). Uso interior. Tacos antideslizantes. Muy fácil de lavar y desinfectar.  
Cadeira. Polipropileno reforçado com fibra de vidro. Injeção por gás. Assento acolchoado (50% vinil/50% poliéster). Uso interior. Tacos antiderrapantes. Muito fácil de lavar e desinfectar.  
Chair. Fiberglass reinforced polypropylene. Gas injection. Upholstered seat (50% vinyl/50% polyester). Indoor use. Non slip caps. Very easy to clean up and disinfect.  
Chaise. Polypropylene renforcé avec fibre de verre. Injection par gaz. Assise tapissée (50% vinyl/50% polyester). Pour l'intérieur. Embouts antidérapants. Très facile à laver et à désinfecter.

Registered design No. 2747774

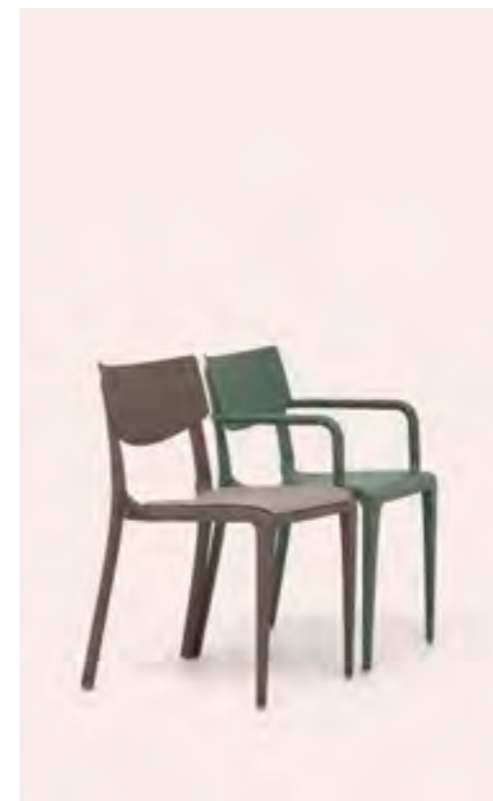

## PARK ARMCHAIR

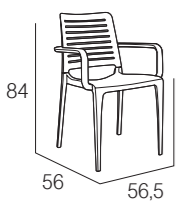

MN-PAR00  
010X00 white



MN-PAR00  
024X00 taupe



MN-PAR00  
091X00 anthracite



MN-PAR00  
083X00 ocean\*



MN-PAR00  
066X00 olivo

## PARK CHAIR \*

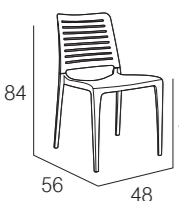

MS-PAR00  
010X00 white



MS-PAR00  
024X00 taupe



MS-PAR00  
091X00 anthracite



MS-PAR00  
083X00 ocean



MS-PAR00  
066X00 olivo

## DOCK

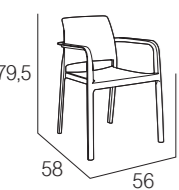

MN-DOC00  
010X00 white



MN-DOC00  
071X00 sand



MN-DOC00  
024X00 taupe



MN-DOC00  
091X00 anthracite



MN-DOC00  
093X00 moka



Sillón apilable. Polipropileno reforzado con fibra de vidrio. Inyección por gas. Tacos antideslizantes.  
Cadeira empilhável. Polipropileno reforçado com fibra de vidro. Injeção por gás. Tacos antiderrapantes.  
Stackable armchair. Fiberglass reinforced polypropylene. Gas injection. Non slip caps.  
Fauteuil empilable. Polypropylène renforcé avec fibre de verre. Injection par gaz. Embouts antidérapants.

Registered design No. 2747774

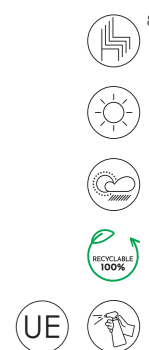

MN-DOC00  
065X00 brick

Sillón apilable. Polipropileno reforzado con fibra de vidrio. Inyección por gas. Tacos antideslizantes.  
Cadeira empilhável. Polipropileno reforçado com fibra de vidro. Injeção por gás. Tacos antiderrapantes.  
Stackable armchair. Fiberglass reinforced polypropylene. Gas injection. Non slip caps.  
Fauteuil empilable. Polypropylène renforcé avec fibre de verre. Injection par gaz. Embouts antidérapants.

Registered design No. 3190040

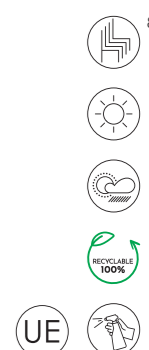

## LAND

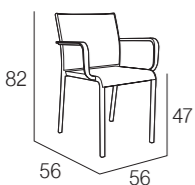

MN-LAN00  
010T11 white



MN-LAN00  
020T11 taupe



MN-LAN00  
091T11 anthracite

## MONACO

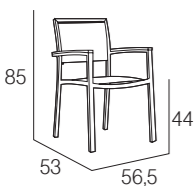

MN-MON01  
010T11 white



MN-MON01  
071T11 sand



MN-MON01  
020T11 taupe



MN-MON01  
091T11 anthracite



MN-MON01  
093T11 moka

## SICILIA

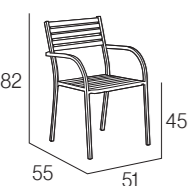

MN-SIC00  
041J00 white



MN-SIC00  
091J00 anthracite



MN-SIC00  
093J00 moka

## 515 (Bake, Hop, Rod, Town, Park, Dock, Sicilia)

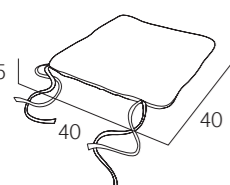

CAY0105150010P1  
101010 taupe



CAY0105150010P1  
110010 anthracite



SOLUTION DYED - COLOUR FASTNESS: 7-8/8 - 100% RECYCLABLE



Sillón apilable. Aluminio lacado. Tejido PhiferTex®. Tacos antideslizantes.

Cadeira empilhável. Alumínio lacado. Tecido PhiferTex®. Tacos antiderrapantes.

Stackable armchair. Lacquered aluminium. PhiferTex® fabric. Non slip caps.

Fauteuil empilable. Aluminium laqué. Toile PhiferTex®. Embouts antidérapants.



PHIFERTEX  
OUTDOOR FABRICS

Sillón apilable. Aluminio lacado. Textiline. Reposabrazos de eco-wood. Tacos antideslizantes.

Cadeira empilhável. Alumínio lacado. Textiline. Repousa braços em eco-wood. Tacos antiderrapantes.

Stackable armchair. Lacquered aluminium. Textiline. Eco-wood armrests. Non slip caps.

Fauteuil empilable. Aluminium laqué. Textiline. Accoudoirs en eco-wood. Embouts antidérapants.



ECOWOOD

Sillón apilable. Aluminio lacado. Lamas asiento en eco-wood. Tacos antideslizantes.

Cadeira empilhável. Alumínio lacado. Ripas assento em eco-wood. Tacos antiderrapantes.

Stackable armchair. Lacquered aluminium. Eco-wood seat slats. Non slip caps.

Fauteuil empilable. Aluminium laqué. Dossier en lamelles eco-wood. Embouts antidérapants.



ECOWOOD



## MEET

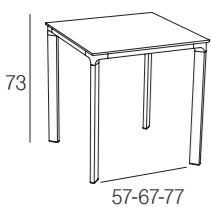

70x70

40MEE04	MHK-MEEC07004
40MEE06	MHK-MEEC07006
40MEE05	MHK-MEEC07005



80x80

40MEE14	MHK-MEEC08004
40MEE16	MHK-MEEC08006
40MEE15	MHK-MEEC08005



90x90

40MEE24	MHK-MEEC09004K
40MEE26	MHK-MEEC09006K
40MEE25	MHK-MEEC09005K

white	
taupe	
anthracite	

Mesa apilable. Estructura de aluminio lacado. Perfil de 58x25x1,6mm con uniones en fundición de aluminio.

Mesa empilhável. Estrutura de alumínio lacado. Perfil de 58x25x1,6mm com uniões em alumínio fundido.

Stackable table. Lacquered aluminium frame. 58x25x1,6mm profiles with die cast aluminium links.

Table empilable. Structure en aluminium laqué. Profile de 58x25x1,6mm assemblée avec de l'aluminium fondu.



## MEET

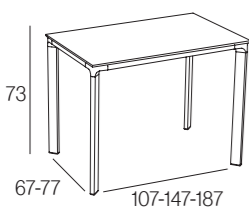

120x80

40MEE104	MHK-MEEH12004K
40MEE106	MHK-MEEH12006K
40MEE105	MHK-MEEH12005K



160x90

40MEE204	MHK-MEEH16004K
40MEE206	MHK-MEEH16006K
40MEE205	MHK-MEEH16005K



200x90

40MEE304	MHK-MEEH20004K
40MEE306	MHK-MEEH20006K
40MEE305	MHK-MEEH20005K

white	
taupe	
anthracite	

Mesa dining. Estructura de aluminio lacado. Perfil de 58x25x1,6mm con uniones en fundición de aluminio.

Mesa dining. Estrutura de alumínio lacado. Perfil de 58x25x1,6mm com uniões em alumínio fundido.

Dinning table. Lacquered aluminium frame. 58x25x1,6mm profiles with die cast aluminium links.

Table dining. Structure en aluminium laqué. Profile de 58x25x1,6mm assemblée avec de l'aluminium fondu.



## MONACO

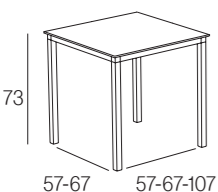

70x70

40MOT04	MHK-MOTC07004
40MOT08	MHK-MOTC07008
40MOT06	MHK-MOTC07006
40MOT05	MHK-MOTC07005
40MOT07	MHK-MOTC07007



80x80

40MOT14	MHK-MOTC08004
40MOT18	MHK-MOTC08008
40MOT16	MHK-MOTC08006
40MOT15	MHK-MOTC08005
40MOT17	MHK-MOTC08007



120x80

40MOT104	MHK-MOTH12004K
40MOT108	MHK-MOTH12008K
40MOT106	MHK-MOTH12006K
40MOT105	MHK-MOTH12005K
40MOT107	MHK-MOTH12007K

white	
sand	
taupe	
anthracite	
moka	

Mesa apilable. Estructura de aluminio lacada con uniones de poliamida con fibra de vidrio. Reguladores de altura.

Mesa empilhável. Estrutura lacada com uniões em poliamida com fibra de vidro. Reguladores de altura.

Stackable table. Lacquered aluminium frame with polyamide with fiberglass connecting pieces. Adjustable leveling feet.

Table empilable. Structure en aluminium laqué avec assemblée en polyamide avec fibre de verre. Pieds sur vérins réglables.



Utility model No. U202030013



## URBAN

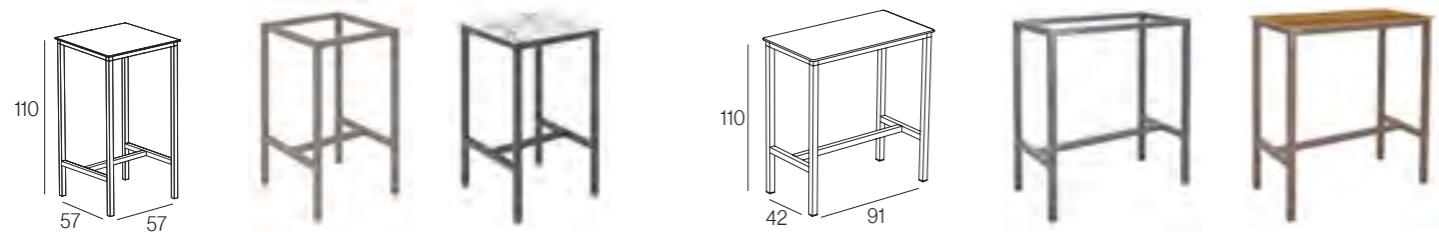

70x70

104x55 \*

white		40URT19	MLK-URTC07009
taupe		40URT17	MLK-URTC07007
anthracite		40URT15	MLK-URTC07005

40URT09	MLK-URTH10409
40URT07	MLK-URTH10407
40URT05	MLK-URTH10405

NEW



120x60

40URT29	MLK-URTH12009
40URT27	MLK-URTH12007
40URT25	MLK-URTH12005

Mesa alta. Estructura de aluminio lacada con uniones de poliamida con fibra de vidrio. Reguladores de altura.  
 Mesa alta. Estrutura lacada com uniões em poliamida com fibra de vidro. Reguladores de altura.  
 High table. Lacquered aluminium frame with polyamide with fiberglass connecting pieces. Adjustable leveling feet.  
 Table haute. Structure en aluminium laqué assemble en polyamide avec fibre de verre. Pieds sur vérins réglables.

Utility model No. U202030013

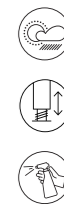

## QUATRO FOLD



60x60

70x70

ø60

ø70

white		40QUA00	MHK-QUAC06000	MHK-QUAC07000	MHK-QUAR06000
sand		40QUA04	MHK-QUAC06004	MHK-QUAC07004	MHK-QUAR06004
taupe		40QUA03	MHK-QUAC06003	MHK-QUAC07003	MHK-QUAR06003
anthracite		40QUA01	MHK-QUAC06001	MHK-QUAC07001	MHK-QUAR06001
moka		40QUA02	MHK-QUAC06002	MHK-QUAC07002	MHK-QUAR06002

MHK-QUAR07000
MHK-QUAR07004
MHK-QUAR07003
MHK-QUAR07001
MHK-QUAR07002



Mesa abatible. Patas de polipropileno reforzado con fibra de vidrio. Tubo de aluminio lacado. Reguladores de altura.  
 Mesa rebatível. Pés de polipropileno reforçado com fibra de vidro. Tubo de alumínio lacado. Reguladores de altura.  
 Folding table. Legs in Fiberglass reinforced polypropylene. Lacquered aluminium tube. Adjustable leveling feet.  
 Table pliante. Piètement en polypropylène renforcé avec fibre de verre. Tube aluminium laqué. Pieds sur vérins réglables.

Registered design No. 3184670



## QUATRO FIX



60x60

70x70

80x80

NEW

taupe		40QUF03	MHK-QUFC06003	MHK-QUFC07003	MHK-QUFC08003
anthracite		40QUF01	MHK-QUFC06001	MHK-QUFC07001	MHK-QUFC08001

Mesa fija. Patas de polipropileno reforzado con fibra de vidrio. Tubo de aluminio lacado. Reguladores de altura.  
 Mesa fixa. Pés de polipropileno reforçado com fibra de vidro. Tubo de alumínio lacado. Reguladores de altura.  
 Fix table. Legs in Fiberglass reinforced polypropylene. Lacquered aluminium tube. Adjustable leveling feet.  
 Table fixe. Piètement en polypropylène renforcé avec fibre de verre. Tube aluminium laqué. Pieds sur vérins réglables.

Registered design No. 3184670

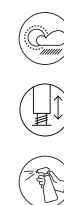

## QUATRO HIGH FIX

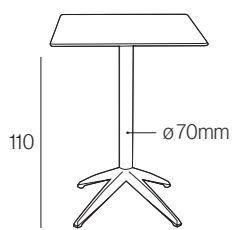

60x60



70x70



ø60



ø70

white



40QUF10

MLK-QUFC06010

MLK-QUFC07010

MLK-QUFR06010

MLK-QUFR07010

sand



40QUF14

MLK-QUFC06014

MLK-QUFC07014

MLK-QUFR06014

MLK-QUFR07014

taupe



40QUF13

MLK-QUFC06013

MLK-QUFC07013

MLK-QUFR06013

MLK-QUFR07013

anthracite



40QUF11

MLK-QUFC06011

MLK-QUFC07011

MLK-QUFR06011

MLK-QUFR07011

moka



40QUF12

MLK-QUFC06012

MLK-QUFC07012

MLK-QUFR06012

MLK-QUFR07012

Mesa alta fija. Patas de polipropileno reforzado con fibra de vidrio. Tubo de aluminio lacado. Reguladores de altura. Pesos para mayor estabilidad.

Mesa alta fixa. Pés de polipropileno reforçado com fibra de vidro. Tubo de alumínio lacado. Reguladores de altura. Pesos para maior estabilidade.

High fix table. Legs in Fiberglass reinforced polypropylene. Lacquered aluminium tube. Adjustable leveling feet. Ballast to add stability.

Table haut fixe. Piètement en polypropylène renforcé avec fibre de verre. Tube aluminium laqué. Pieds sur vérins réglables. Leste's pour plus de stabilité.

Registered design No. 3184670



## QUATRO DUO FIX

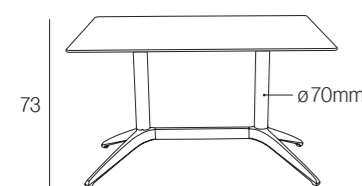

120X80

white



40QUF000

MHK-QUFH12000

sand



40QUF004

MHK-QUFH12004

taupe



40QUF003

MHK-QUFH12003

anthracite



40QUF001

MHK-QUFH12001

Mesa fija. Patas de polipropileno reforzado con fibra de vidrio. Tubo de aluminio lacado. Reguladores de altura.

Mesa fixa. Pés de polipropileno reforçado com fibra de vidro. Tubo de alumínio lacado. Reguladores de altura.

Fix table. Legs in Fiberglass reinforced polypropylene. Lacquered aluminium tube. Adjustable leveling feet.

Table fixe. Piètement en polypropylène renforcé avec fibre de verre. Tube aluminium laqué. Pieds sur vérins réglables.

Registered design No. 3184670



## ONE



70x70

white



42ONE10

MHK-ONEC07000

sand



42ONE15

MHK-ONEC07005

taupe



42ONE12

MHK-ONEC07002

anthracite



42ONE11

MHK-ONEC07001

Mesa apilable. Patas de polipropileno reforzado con fibra de vidrio. Inyección por gas.

Mesa empilhável. Pés de polipropileno reforçado com fibra de vidro. Injeção por gás.

Stackable table. Legs in Fiberglass reinforced polypropylene. Gas injection.

Table empilable. Piètement en polypropylène renforcé avec fibre de verre. Injection par gaz.

Registered design No. 2747972



## RODAS



70x70

white   
 taupe   
 anthracite

40BR001  
 40TR000  
 40AR000

MHK-BROC07000  
 MHK-TROC07000  
 MHK-AROC07000



Mesa apilable. Tubo acero lacado.  
 Mesa empilhável. Tubo aço lacado.  
 Stackable table. Lacquered steel tube.  
 Table empilable. Tube acier laqué.



## KOS

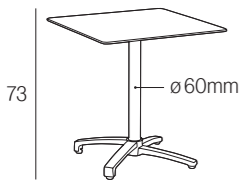

60X60



70X70



Ø60

white   
 taupe   
 anthracite

42KOS00  
 42KOS01  
 42KOS02

MHK-KOSC06000  
 MHK-KOSC06001  
 MHK-KOSC06002

MHK-KOSC07000  
 MHK-KOSC07001  
 MHK-KOSC07002

MHK-KOSR06000  
 MHK-KOSR06001  
 MHK-KOSR06002



Ø70

MHK-KOSR07000  
 MHK-KOSR07001  
 MHK-KOSR07002

Mesa abatible. Pata aluminio lacado. Reguladores de altura.  
 Mesa rebatível. Pé alumínio lacado. Reguladores de altura.  
 Folding table. Lacquered aluminium leg. Adjustable leveling feet.  
 Table pliante. Pied aluminium laqué. Sur vérins réglables.



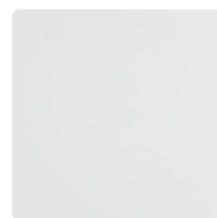

WHITE  
010K00

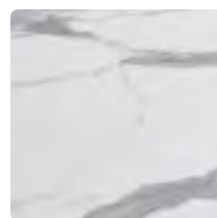

WHITE MARBLE  
013K00

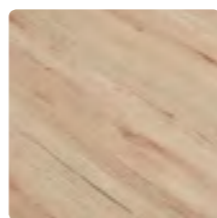

OAK  
092K00

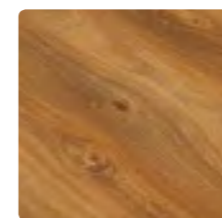

DARK OAK  
093K00

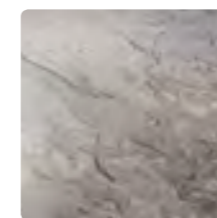

STONE  
028K00

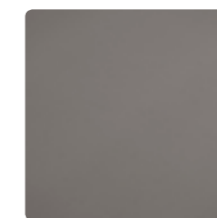

TAUPE  
020K00

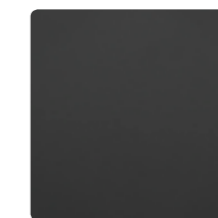

ANTHRACITE \*  
091K00

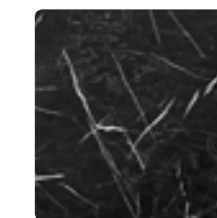

BLACK MARBLE \*  
094K00

60x60		45K00C06000-010K00	45K00C06000-013K00	45K00C06000-092K00
70x70		45K00C07000-010K00	45K00C07000-013K00	45K00C07000-092K00
80x80		45K00C08000-010K00	45K00C08000-013K00	45K00C08000-092K00
90x90		45K00C09000-010K00		
120x80		45K00H12000-010K00	45K00H12000-013K00	45K00H12000-092K00
160x90		45K00H16001-010K00		
200x90		45K00H20000-010K00		
ø60		45K00R06000-010K00		45K00R06000-092K00
ø70		45K00R07000-010K00		45K00R07000-092K00
104x55 (urban) **		45K00H10400-010K00	45K00H10400-013K00	45K00H10400-092K00
120x60 (urban)		45K00H12001-010K00	45K00H12001-013K00	45K00H12001-092K00
70x70 (one)		45K00C07001-010K00	45K00C07001-013K00	45K00C07001-092K00
60x70 **		45K00H06002-010K00	45K00H06002-013K00	45K00H06002-092K00

45K00C06000-093K00	45K00C06000-028K00	45K00C06000-020K00	45K00C06000-091K00	45K00C06000-094K00
45K00C07000-093K00	45K00C07000-028K00	45K00C07000-020K00	45K00C07000-091K00	45K00C07000-094K00
45K00C08000-093K00	45K00C08000-028K00	45K00C08000-020K00	45K00C08000-091K00	45K00C08000-094K00
	45K00C09000-028K00	45K00C09000-020K00	45K00C09000-091K00	
45K00H12000-093K00	45K00H12000-028K00	45K00H12000-020K00	45K00H12000-091K00	45K00H12000-094K00
	45K00H16001-028K00	45K00H16001-020K00	45K00H16001-091K00	
	45K00H20000-028K00	45K00H20000-020K00	45K00H20000-091K00	
45K00R06000-093K00		45K00R06000-020K00		
45K00R07000-093K00		45K00R07000-020K00		
45K00H10400-093K00	45K00H10400-028K00	45K00H10400-020K00	45K00H10400-091K00	45K00H10400-094K00
45K00H12001-093K00	45K00H12001-028K00	45K00H12001-020K00	45K00H12001-091K00	45K00H12001-094K00
45K00C07001-093K00	45K00C07001-028K00	45K00C07001-020K00	45K00C07001-091K00	45K00C07001-094K00
45K00H06002-093K00	45K00H06002-028K00	45K00H06002-020K00	45K00H06002-091K00	45K00H06002-094K00

Tablero termolaminado compacto decorativo (10mm). Formado en la cara exterior por papel decorativo impregnado y en el interior por papel kraft impregnado con resinas termoestables. A este material se le aplica en la prensa temperatura y presión de forma simultánea para conseguir un tablero compacto de alta densidad.

Decorative pressed laminated table top (10mm). Interior composed of thermostable resin kraft paper and surface lined with impregnated decorative paper. The compound is pressed simultaneously at high temperature and pressure to obtain a high density compacted table top.

Tampo termolaminado compacto decorativo (10mm). A sua face exterior é formada por papel decorativo impregnado e o seu interior por papel kraft impregnado com resinas termoestáveis. O conjunto é prensado por meio de calor e alta pressão de forma simultânea para conseguir um tampo compacto de alta densidade.

Plateau stratifié compact décoratif (10mm). Formé sur sa face extérieure par du papier décoratif imprégné et dans son intérieur par du papier kraft imprégné avec des résines thermostables. L'ensemble est ensuite pressé sous l'action de la chaleur et de la haute pression, simultanément, afin d'obtenir un plateau compact de haute densité.

\* No se recomiendan los colores oscuros para zonas muy soleadas - Não se recomendam cores escuras para zonas muito soalheiras - Dark colors are not recommended for very sunny areas - Les couleurs foncées ne sont pas recommandées pour les zones très ensoleillées.

## LAGO

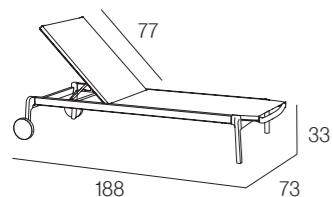

MU-LAG00  
010T11 white/white



MU-LAG00  
020T11 taupe/taupe



MU-LAG00  
066T11 taupe/tweed olivo



Tumbona apilable. Estructura de aluminio lacado. Patas de polipropileno reforzado con fibra de vidrio. Tejido Phifertex®. Respaldo abatible 5 posiciones. Ruedas.

*Espreguiçadeira empilhável. Estrutura alumínio lacado. Pés de polipropileno reforçado com fibra de vidro. Tecido Phifertex®. Encosto rebatível 5 posições. Rodas.*

Stackable sun lounger. Lacquered aluminium structure. Legs in fiberglass reinforced polypropylene. Phifertex® fabric. Reclining backrest with 5 positions. Wheels.

*Bain de soleil empilable. Structure aluminium laqué. Piétement en polypropylène renforcé avec fibre de verre. Toile Phifertex®. Dossier rabattable 5 positions. Roues.*

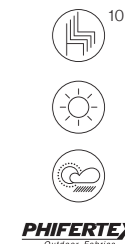

PHIFERTEX  
Outdoor Fabrics

Registered design No. 008735179

## VILA

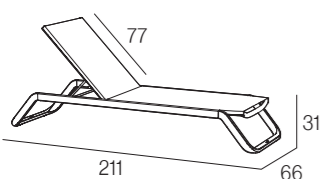

MU-VLA00  
010T11 white/white



MU-VLA02  
020T11 white/taupe



MU-VLA00  
020T11 taupe/taupe



MU-VLA00  
091T11 anthracite/anthracite



MU-VLA00  
066T11 taupe/tweed olivo

NEW

Tumbona apilable. Estructura de aluminio lacado. Patas de polipropileno reforzado con fibra de vidrio. Tejido Phifertex®. Respaldo abatible 5 posiciones. Ruedas.

*Espreguiçadeira empilhável. Estrutura alumínio lacado. Pés de polipropileno reforçado com fibra de vidro. Tecido Phifertex®. Encosto rebatível 5 posições. Rodas.*

Stackable sun lounger. Lacquered aluminium structure. Legs in fiberglass reinforced polypropylene. Phifertex® fabric. Reclining backrest with 5 positions. Wheels.

*Bain de soleil empilable. Structure aluminium laqué. Piétement en polypropylène renforcé avec fibre de verre. Toile Phifertex®. Dossier rabattable 5 positions. Roues.*

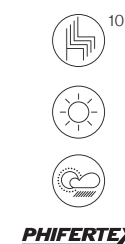

PHIFERTEX  
Outdoor Fabrics

Registered design No. 4410330 - Utility model No. U201731460

## VILA ARMS \*

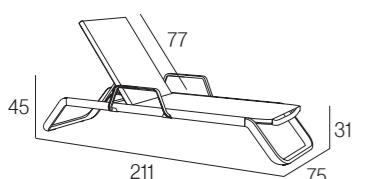

MU-VLA01  
010T11 white/white



MU-VLA03  
020T11 white/taupe



MU-VLA01  
020T11 taupe/taupe



MU-VLA01  
091T11 anthracite/anthracite



MU-VLA01  
066T11 taupe/tweed olivo

NEW

Tumbona apilable con brazos. Estructura de aluminio lacado. Patas de polipropileno reforzado con fibra de vidrio. Tejido Phifertex®. Respaldo abatible 5 posiciones. Ruedas.

*Espreguiçadeira empilhável com braços. Estrutura alumínio lacado. Pés de polipropileno reforçado com fibra de vidro. Tecido Phifertex®. Encosto rebatível 5 posições. Rodas.*

Stackable sun lounger with arms. Lacquered aluminium structure. Legs in fiberglass reinforced polypropylene. Phifertex® fabric. Reclining backrest with 5 positions. Wheels.

*Bain de soleil empilable avec accoudoirs. Structure aluminium laqué. Piétement en polypropylène renforcé avec fibre de verre. Toile Phifertex®. Dossier rabattable 5 positions. Roues.*

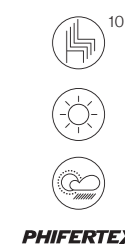

PHIFERTEX  
Outdoor Fabrics

Registered design No. 4410330 - Utility model No. U201731460

## VILA

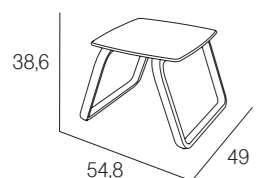

MAK-VLAC04505  
white



MAK-VLAC04506  
taupe



MAK-VLAC04507  
anthracite



Mesa auxiliar apilable. Patas de polipropileno reforzado con fibra de vidrio. Tablero compacto.

*Mesa auxiliar empilhável. Pés de polipropileno reforçado com fibra de vidro. Tampo compacto.*

Stackable side table. Legs in fiberglass reinforced polypropylene. Compact table top.

*Table auxiliaire empilable. Piétement en polypropylène renforcé avec fibre de verre. Plateaux compact.*

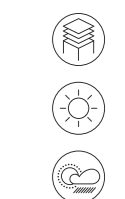

PHIFERTEX  
Outdoor Fabrics

Registered design No. 006954285

## AQUA & NAUTIC

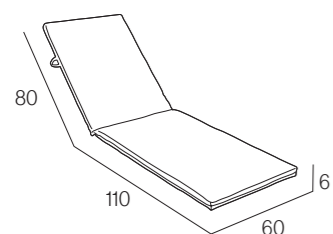

CTQT00681001P1  
003T00 white  
(AQUA)



CTQT00681001P1  
020T00 taupe  
(AQUA)



CTQT00681001P1  
001T00 beige  
(AQUA)



CTQP07681001C1  
010P07 white  
(NAUTIC)



CTQP07681001C1  
020P07 taupe  
(NAUTIC)

Cojines AQUA. Textilene. Permeable al agua.

*Almofadas AQUA. Textilene. Permeável à água.*

AQUA Cushions. Textilene. Water permeable.

*Coussins AQUA. Textilene. Perméable à l'eau.*

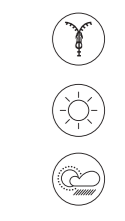

AQUA  
PERMEABLE

Cojines NAUTIC\*. Tejido náutico. Repelente al agua.

*Almofadas NAUTIC\*. Tecido náutico. Repelente à água.*

NAUTIC\* Cushions. Nautic fabric. Water repellent.

*Coussins NAUTIC\*. Toile Nautic. Deperlante.*

UE  
NAUTIC  
WATERPROOF

## NANA

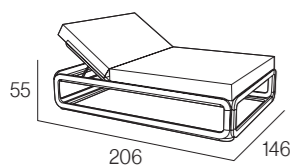

MQ-NAN00140X200BC  
white



MQ-NAN00140X200TP  
taupe

## IBIZA

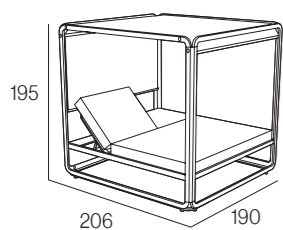

MQ-IBI01D00180X200BC  
844 white



MQ-IBI01D00180X200BC  
807 taupe



MQ-IBI01D00180X200TP  
807 taupe

Estructura aluminio lacado. Tornillería acero inox lacada.  
Conexiones en poliamida con fibra de vidrio. Colchón tejido  
Nautic\*. Abatible.

*Estrutura alumínio lacado. Parafusos aço inox lacado. Conexões  
em poliamida com fibra de vidro. Colchão tecido Nautic\*.  
Rebatível.*

Lacquered aluminium structure. Lacquered stainless steel  
screws. Polyamide with fiberglass connecting pieces. Nautic\*  
mattress. Folding.

*Structure aluminium laqué. Visserie acier inox laqué. Connexions  
en polyamide avec fibre de verre. Matelas Toile Nautic\*. Pliant.*



Estructura aluminio lacado. Tornillería acero inox lacada.  
Conexiones en poliamida con fibra de vidrio. Tejido Dralon®.  
Colchón tejido Nautic\*. Abatible.

*Estrutura alumínio lacado. Parafusos aço inox lacado. Conexões  
em poliamida com fibra de vidro. Tecido Dralon®. Colchão tecido  
Nautic\*. Rebatível.*

Lacquered aluminium structure. Lacquered stainless steel  
screws. Polyamide with fiberglass connecting pieces. Dralon®  
fabric. Nautic\* mattress. Folding.

*Structure aluminium laqué. Visserie acier inox laqué. Connexions  
en polyamide avec fibre de verre. Toile Dralon®. Matelas Toile  
Nautic\*. Pliant.*



## MARINE SINGLE SOFA

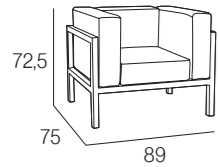

MF-MAR01-010A02  
010P07 white nautic



CPF-MARP07280P  
SET 4 cojines - almofadas - cushions - coussins  
010P07 white nautic

## MARINE CORNER SOFA

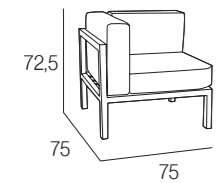

MF-MAR00-010A02  
010P07 white nautic

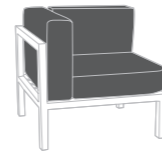

CPF-MARP07282P  
SET 3 cojines - almofadas - cushions - coussins  
010P07 white nautic

## MARINE IN-BETWEEN SOFA

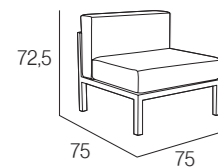

MF-MAR04-010A02  
010P07 white nautic



CPF-MARP07283P  
SET 2 cojines - almofadas - cushions - coussins  
010P07 white nautic

## MARINE POUF

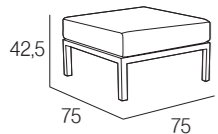

MC-MAR00-010A02  
010P07 white nautic



CPP-MARP07284P  
SET 1 cojín - almofada - cushion - coussin  
010P07 white nautic  
75 x 75 x 15 cm

## MARINE TABLE

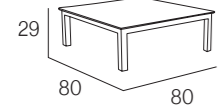

45K00C08000-010K00  
white compact



45K00C08000  
010K00 white compact  
80 x 80 cm

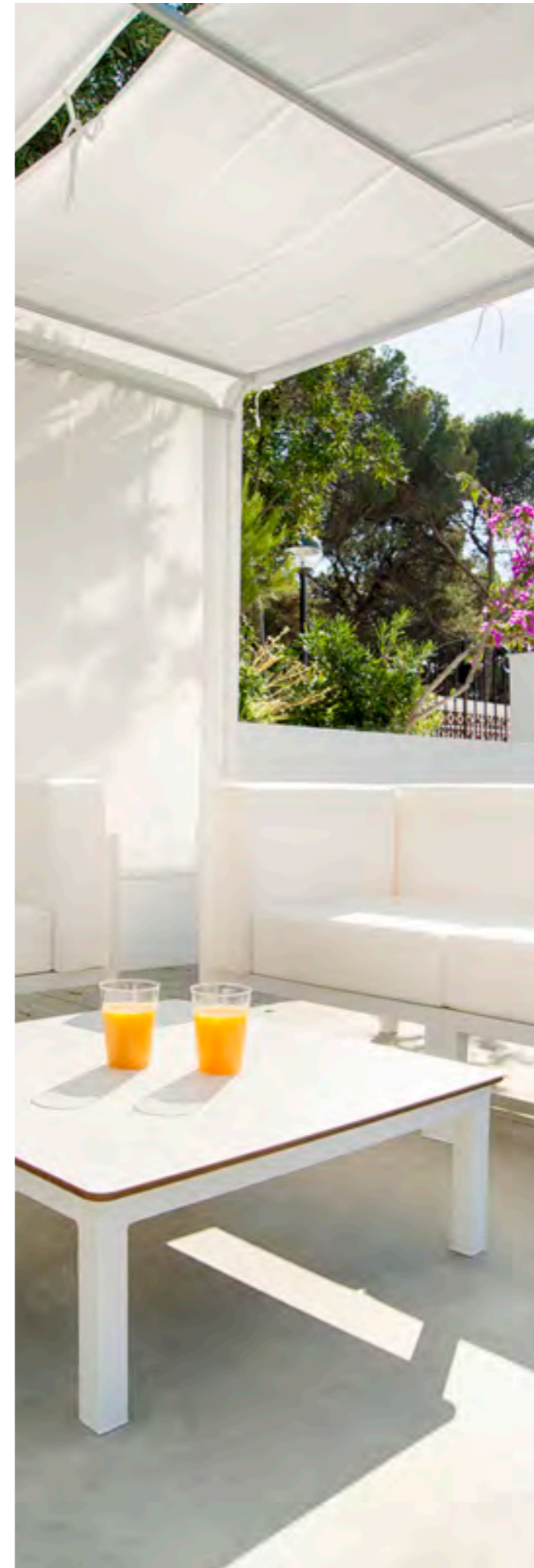

Sofá individual. Aluminio lacado blanco. Anclaje para unión entre piezas. Cojines tejido Nautic\*.  
Sofá individual. Alumínio lacado branco. Fixador de união entre peças. Almofadas tecido Nautic\*.  
Single sofa. White lacquered aluminium. Locking system between pieces. Nautic\* fabric cushions.  
Canapé individuel. Aluminium laqué blanc. Éléments de fixation entre modules. Coussins toile Nautic\*.



Sofá esquinero. Aluminio lacado blanco. Anclaje para unión entre piezas. Cojines tejido Nautic\*.  
Sofá de canto. Alumínio lacado branco. Fixador de união entre peças. Almofadas tecido Nautic\*.  
Corner sofa. White lacquered aluminium. Locking system between pieces. Nautic\* fabric cushions.  
Canapé d'angle. Aluminium laqué blanc. Éléments de fixation entre modules. Coussins toile Nautic\*.



Sofá intermedio. Aluminio lacado blanco. Anclaje para unión entre piezas. Cojines tejido Nautic\*.  
Sofá intermédio. Alumínio lacado branco. Fixador de união entre peças. Almofadas tecido Nautic\*.  
In-between sofa. White lacquered aluminium. Locking system between pieces. Nautic\* fabric cushions.  
Canapé intermediaire. Aluminium laqué blanc. Éléments de fixation entre modules. Coussins toile Nautic\*.



Pouf. Aluminio lacado blanco. Anclaje para unión entre piezas. Cojín tejido Nautic\*.  
Pouf. Alumínio lacado branco. Fixador de união entre peças. Almofadas tecido Nautic\*.  
Pouf. White lacquered aluminium. Locking system between pieces. Nautic\* fabric cushions.  
Pouf. Aluminium laqué blanc. Éléments de fixation entre modules. Coussins toile Nautic\*.



**COMPACT**

Mesa aluminio lacado blanco. Anclaje para unión entre piezas. Tablero Compact 80x80.  
Mesa alumínio lacado branco. Fixador de união entre peças. Tampo Compact 80x80.  
White lacquered aluminium table. Locking system between pieces. 80x80 Compact table top.  
Table aluminium laqué blanc. Éléments de fixation entre modules. Plateau Compact 80x80.



**COMPACT**

## SIENA MAXI MODULE METHACRYLATE

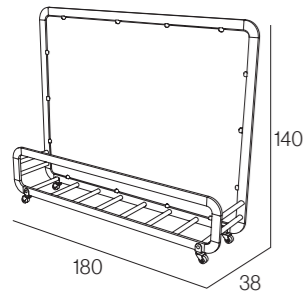

MO-MSIE05A  
anthracite



MO-MSIE05B  
white



MO-MSIE05T  
taupe

Módulo separador. Aluminio lacado y anodizado. Tornillería acero inox. 4 ruedas (2 con freno). Conexiones en poliamida con fibra de vidrio. Metacrilato transparente 5 mm.

*Módulo separador. Aluminio lacado e anodizado. Acessórios em aço inox. 4 rodas (2 com travão). Conexões em poliamida com fibra de vidro. Metacrilato transparente 5 mm.*

Divider module. Lacquered and anodized aluminium. Stainless steel hardware. 4 wheels (2 with brake). Polyamide with fiberglass connecting pieces. Transparent methacrylate 5 mm.

*Module séparateur. Aluminium laqué et anodisé. Visserie en acier inox. 4 roues (2 avec frein). Pièces de connection en polyamide avec fibre de verre. Méthacrylate transparent 5mm.*



+ INFO



## SIENA MAXI MODULE OLEFIN

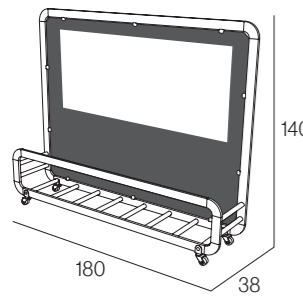

MO-V010SIE05A  
anthracite



MO-V010SIE051B  
white



MO-V010SIE05T  
taupe

Módulo separador. Aluminio lacado y anodizado. Tornillería acero inox. 4 ruedas (2 con freno). Conexiones en poliamida con fibra de vidrio. Tejido Olefin® con ventana.

*Módulo separador. Aluminio lacado e anodizado. Acessórios em aço inox. 4 rodas (2 com travão). Conexões em poliamida com fibra de vidro. Tecido Olefin® com janela.*

Divider module. Lacquered and anodized aluminium. Stainless steel hardware. 4 wheels (2 with brake). Polyamide with fiberglass connecting pieces. Olefin® fabric with window.

*Module séparateur. Aluminium laqué et anodisé. Visserie en acier inox. 4 roues (2 avec frein). Pièces de connection en polyamide avec fibre de verre. Tissu Olefin® avec fenêtre.*



+ INFO



## SIENA MAXI PANEL METHACRYLATE

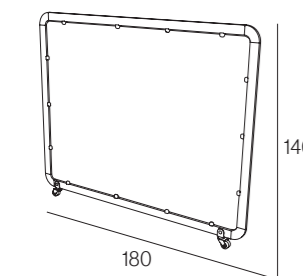

MO-MSIE03A  
anthracite



MO-MSIE03B  
white



MO-MSIE03T  
taupe

Panel separador. Aluminio lacado y anodizado. Tornillería acero inox. 2 ruedas con freno. Conexiones en poliamida con fibra de vidrio. Metacrilato transparente 5 mm.

*Painel separador. Aluminio lacado e anodizado. Acessórios em aço inox. 2 rodas com travão. Conexões em poliamida com fibra de vidro. Metacrilato transparente 5 mm.*

Divider Panel. Lacquered and anodized aluminium. Stainless steel hardware. 2 wheels with brake. Polyamide with fiberglass connecting pieces. Transparent methacrylate 5 mm.

*Panneau séparateur. Aluminium laqué et anodisé. Visserie en acier inox. 2 roues avec frein. Pièces de connection en polyamide avec fibre de verre. Méthacrylate transparent 5mm.*



+ INFO



## SIENA MAXI PANEL OLEFIN

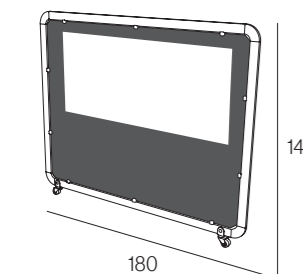

MO-V010SIE03A  
anthracite



MO-V010SIE031B  
white



MO-V010SIE03T  
taupe

Panel separador. Aluminio lacado y anodizado. Tornillería acero inox. 2 ruedas con freno. Conexiones en poliamida con fibra de vidrio. Tejido Olefin® con ventana.

*Painel separador. Aluminio lacado e anodizado. Acessórios em aço inox. 2 rodas com travão. Conexões em poliamida com fibra de vidro. Tecido Olefin® com janela.*

Divider Panel. Lacquered and anodized aluminium. Stainless steel hardware. 2 wheels with brake. Polyamide with fiberglass connecting pieces. Olefin® fabric with window.

*Panneau séparateur. Aluminium laqué et anodisé. Visserie en acier inox. 2 roues avec frein. Pièces de connection en polyamide avec fibre de verre. Tissu Olefin® avec fenêtre.*



+ INFO





## SIENA MINI MODULE/PANEL METHACRYLATE \*

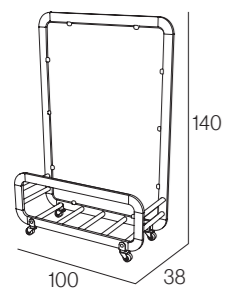

MO-MSIE06A  
anthracite



MO-MSIE04A  
anthracite



MO-MSIE062B  
white



MO-MSIE042B  
white



MO-MSIE06T  
taupe



MO-MSIE04T  
taupe

Módulo/panel separador. Aluminio lacado y anodizado. Tornillería acero inox. Módulo: 4 ruedas (2 con freno), Panel: 2 ruedas con freno. Conexiones en poliamida con fibra de vidrio. Metacrilato transparente 5 mm.

Módulo/panel separador. Alumínio lacado e anodizado. Acessórios em aço inox. Módulo: 4 rodas (2 com travão), Painel: 2 rodas com travão. Conexões em poliamida com fibra de vidro. Metacrilato transparente 5 mm.

Module/divider panel. Lacquered and anodized aluminium. Stainless steel hardware. Module: 4 wheels (2 with brake), Panel: 2 wheels with brake. Polyamide with fiberglass connecting pieces. Transparent methacrylate 5 mm.

Module/panneau séparateur. Aluminium laqué et anodisé. Visserie en acier inox. Module: 4 roues (2 avec frein), Panneau: 2 roues avec frein. Pièces de connection en polyamide avec fibre de verre. Méthacrylate transparent 5 mm.



+ INFO



## SIENA MINI MODULE/PANEL OLEFIN

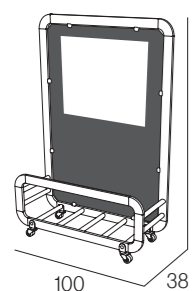

MO-V010SIE06A  
anthracite



MO-V010SIE04A  
anthracite



MO-V010SIE061B  
white



MO-V010SIE041B  
white



MO-V010SIE06T  
taupe



MO-V010SIE04T  
taupe

Módulo/panel separador. Aluminio lacado y anodizado. Tornillería acero inox. Módulo: 4 ruedas (2 con freno), Panel: 2 ruedas con freno. Conexiones en poliamida con fibra de vidrio. Tejido Olefin® con ventana.

Módulo/panel separador. Alumínio lacado e anodizado. Acessórios em aço inox. Módulo: 4 rodas (2 com travão), Painel: 2 rodas com travão. Conexões em poliamida com fibra de vidro. Tecido Olefin® com janela.

Module/divider panel. Lacquered and anodized aluminium. Stainless steel hardware. Module: 4 wheels (2 with brake), Panel: 2 wheels with brake. Polyamide with fiberglass connecting pieces. Olefin® fabric with window.

Module/panneau séparateur. Aluminium laqué et anodisé. Visserie en acier inox. Module: 4 roues (2 avec frein), Panneau: 2 roues avec frein. Pièces de connection en polyamide avec fibre de verre. Tissu Olefin® avec fenêtre.



+ INFO



## ACCESSORIES



Pernio para pared - dobradiça para parede - wall fitting - joint flexible pour mur.



MO-SIE52A  
anthracite



MO-SIE52B  
white



MO-SIE52T  
taupe



Jardinera - jardineira - flowerpot - jardinière. 80x30x30 cm.



MO-JAR03  
black



MO-JAR04  
white



Pernio individual - dobradiça individual - individual fittings - joint flexible individuel.



MO-SIE53A  
anthracite



MO-SIE53B  
white



MO-SIE53T  
taupe



## EOLO PURETI



white/white

taupe/sand

taupe/taupe

anthracite/ anthracite

### Tamaños / Tamanhos / Sizes / Tailles

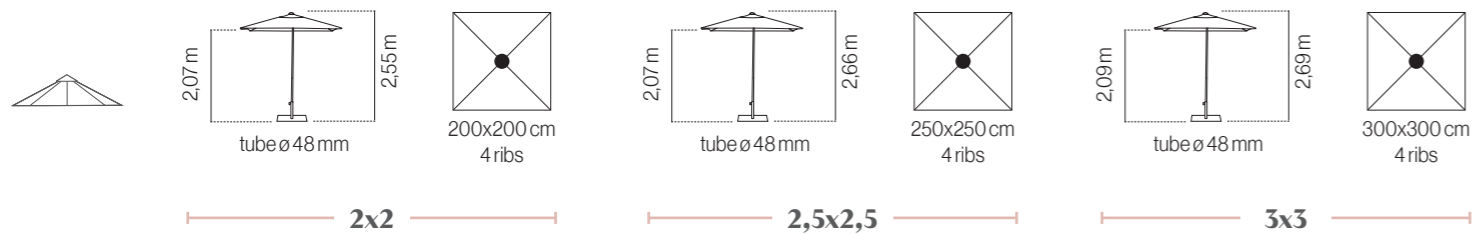

2x2

2,5x2,5

3x3

### Tejidos / Tecidos / Fabrics / Tissus

#### Olefin



112010 white



103010 sand



101010 taupe



110010 anthracite

### Bases / Pieds (Pag. 186-187)

•CUBE •FIX •FASTCLICK •ROUND •MOULD •BOND •FLAT •CANTO

### Referencias / Referências / References / Références

Color frame	2x2	2,5x2,5	3x3
white	SPA010C2002721P	SIA010C2501720P	SGA010C3002720P
taupe	SPA010C2002821P	SIA010C2501820P	SGA010C3002820P
anthracite	SPA010C2002621P	SIA010C2501620P	SGA010C3002620P



Parasol de aluminio lacado con 4 varillas (20x14mm.). Apertura tipo push-up con sistema abre/cierra y pulsador de bloqueo. Sin volante y con fugavientos.

Guarda-sol em alumínio lacado com 4 varetas (20x14mm.). Abertura tipo push-up com sistema abre/fecha e botão de bloqueio. Sem bambinela e com fugaventos.

Lacquered aluminum parasol with 4 ribs (20x14mm.). Easy push-up open system with an open-lock handle. Without valance and with airvent.

Parasol aluminium laqué avec 4 baleines (20x14mm.). Ouverture push-up avec système d'ouverture / fermeture et verrouillage. Sans volant et avec soufflet.

Registered design No. 007003710 - Utility model No. 201931894



## EL PARASOL QUE PURIFICA EL AIRE - O GUARDA-SOL QUE PURIFICA O AR THE PARASOL THAT PURIFIES THE AIR - LE PARASOL QUI PURIFIE L'AIR

pureti



Al igual que los árboles, el tejido de este parasol descontamina el aire de las ciudades, neutraliza los gases de los motores y otras sustancias nocivas. Incorpora una nanotecnología que, en contacto con la luz solar, convierte las sustancias contaminantes del aire en sales inertes.

Tal como as árvores, o tecido deste guarda-sol descontamina o ar das cidades, neutraliza os gases dos motores e outras substâncias nocivas. Tem incorporada uma nanotecnologia que, em contacto com a luz solar, converte as substâncias contaminantes do ar em sais inertes.

Much like trees, the fabric of this umbrella reduces city pollution, neutralizing engine gases and other harmful substances. Its nanotechnology, upon contact with sunlight, turns air pollutants into inert salts.

Tout comme les arbres, le tissu de ce parasol décontamine l'air des villes et neutralise les gaz d'échappement des moteurs et d'autres substances nocives. Il intègre une nanotechnologie qui, en contact avec la lumière du soleil, transforme les substances contaminantes de l'air en sels inertes.



white

taupe

anthracite

Tamaños / Tamanhos / Sizes / Tailles

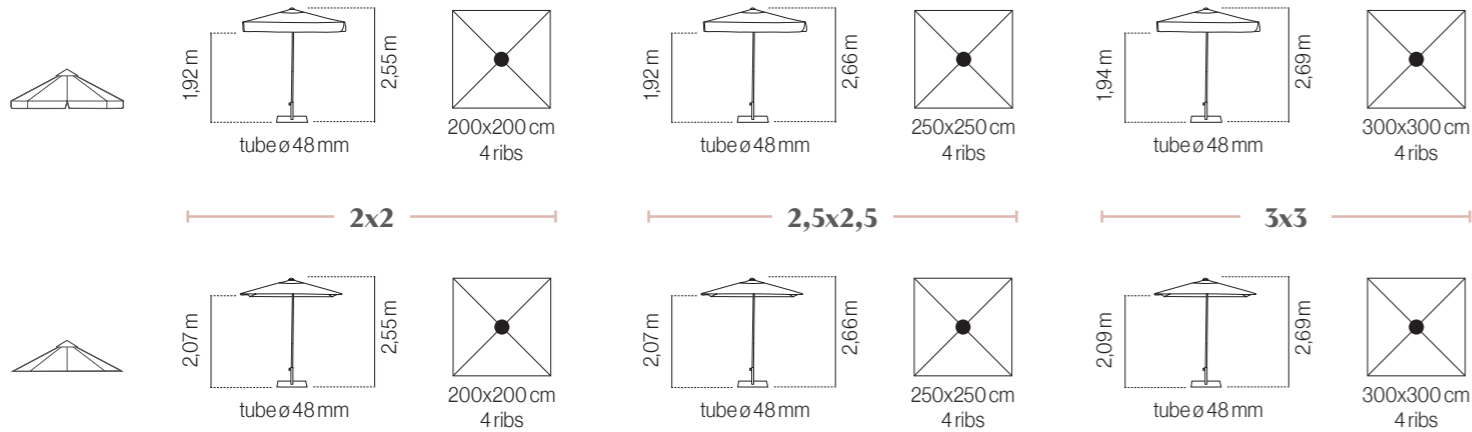

Tejidos / Tecidos / Fabrics / Tissus

Olefin



Sumbrella

NEW

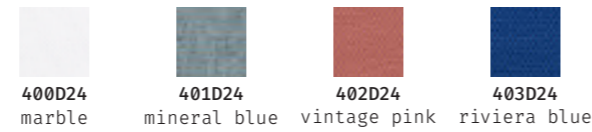

Bases / Pieds (Pag. 186-187)

- CUBE •FIX •FASTCLICK •ROUND •MOULD •BOND •FLAT •CANTO



Parasol de aluminio lacado con 4 varillas (20x14mm). Apertura tipo push-up con sistema abre/cierra y pulsador de bloqueo. Sin volante y con fugavientos.

Guarda-sol em alumínio lacado com 4 varetas (20x14mm). Abertura tipo push-up com sistema abre/fecha e botão de bloqueio. Sem bambinela e com fugaventos.

Lacquered aluminum parasol with 4 ribs (20x14mm.). Easy push-up open system with an open-lock handle. Without valance and with airvent.

Parasol aluminium laqué avec 4 baleines (20x14mm.). Ouverture push-up avec système d'ouverture / fermeture et verrouillage. Sans volant et avec soufflet.

Registered design No. 007003710 - Utility model No. 201931894



Referencias / Referências / References / Références

	Color frame	2x2	2,5x2,5	3x3
olefin	white	SPA010C2002740P	SIA010C2502740P	SGA010C3002740P
	taupe	SPA010C2002840P	SIA010C2502840P	SGA010C3002840P
	anthracite	SPA010C2002640P	SIA010C2502640P	SGA010C3002640P
olefin	white	SPA010C2002720P	SIA010C2502721P	SGA010C3002721P
	taupe	SPA010C2002820P	SIA010C2502821P	SGA010C3002821P
	anthracite	SPA010C2002620P	SIA010C2502621P	SGA010C3002621P
sumbrella	white	SPAD24C2002770P	SIAD24C2502771P	SGAD24C3002771P
	taupe	SPAD24C2002870P	SIAD24C2502871P	SGAD24C3002871P
	anthracite	SPAD24C2002670P	SIAD24C2502671P	SGAD24C3002671P

# FLEXO 3x3



white



taupe



anthracite

NEW

## Tamaños / Tamanhos / Sizes / Tailles

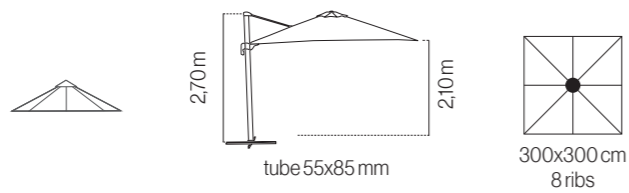

## Tejidos / Tecidos / Fabrics / Tissus

### Olefin

112010 white	103010 sand	101010 taupe	110010 anthracite	102010 black	109010 moka	121010 olivo
123010 ice	122010 sky blue	117010 navy	115010 taupe stripe	116010 anthracite stripe	125010 blue stripe	124010 green stripe

## Bases / Pieds (Pag. 186-187)

•SLAB •KITFLEXO

## Referencias / Referências / References / Références



Color frame	3x3
white	SGA010C3005021P
taupe	SGA010C3005022P
anthracite	SGA010C3005020P



Parasol de aluminio 3x3 m de mastil lateral con inclinación. 8 varillas (17x25 mm). Giratorio 360°. Sistema estabilizador. Sin volante y con fugavientos.

Guarda-sol em alumínio 3x3 m. de haste lateral com inclinação. 8 varetas (17x25 mm). Giratório 360°. Sistema estabilizador. Sem bambelina e com fugaventos.

3x3 m. aluminium lateral pole parasol with tilt system. 8 ribs (17x25 mm). 360° rotatory system. Stabilizer system. Without valance and with airvent.

Parasol mât 3x3 m. latéral avec inclinaison. 8 baleines (17x25 mm). Rotatif 360°. Système stabilisateur. Sans volant et avec soufflet.

(Cruceta incluida / cruzeta incluída / cross included / croix incluse)

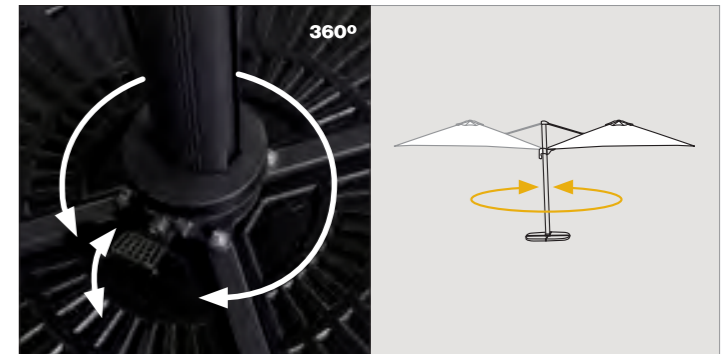
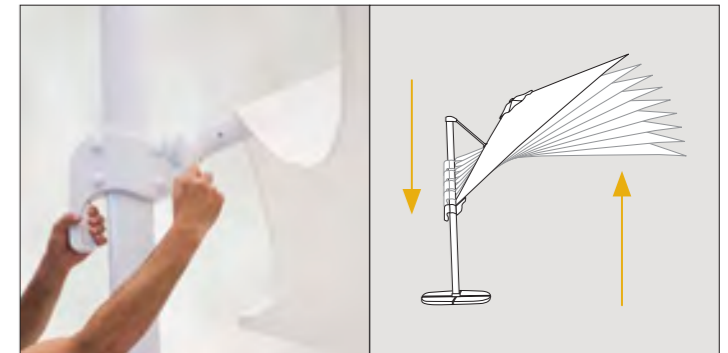

# RIO 4x4



white



anthracite

## Tamaños / Tamanhos / Sizes / Tailles

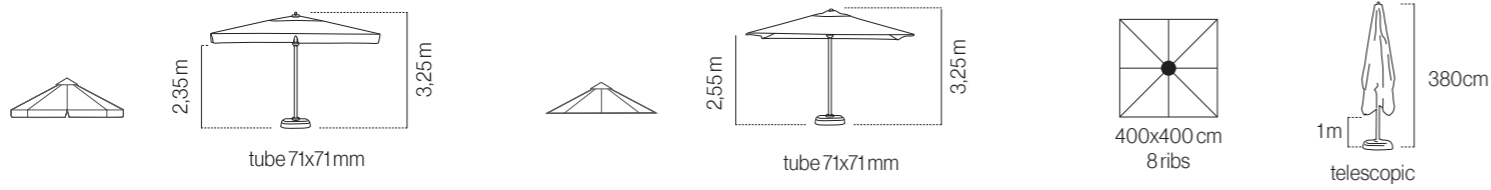

## Tejidos / Tecidos / Fabrics / Tissus

### Olefin 250g



### Waterproof

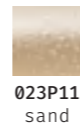

## Bases / Pieds (Pag. 186-187)

•KIT CROSSRIO •FIXRIO •FAST CLICKRIO

## Referencias / Referências / References / Références

	Color frame	4x4 olefin
olefin	white	SGA020C4000240P
	anthracite	SGA020C4000440P
olefin	white	SGA020C4000220P
	anthracite	SGA020C4000420P
waterproof	white	SGAP11C4000340P
	anthracite	SGAP11C4000440P



Parasol de aluminio lacado para terrazas grandes 4x4 m. 8 varillas intercambiables (20x35x1,5 mm). Apertura asistida manivela. Telescópico. Con o sin volante y con fugavientos.

Guarda-sol em alumínio lacado para esplanadas grandes 4x4 m. 8 varetas intercambiáveis (20x35x1,5 mm). Abertura assistida manivela. Telescópico. Com ou sem bambinela e com fugaventos.

Lacquered 4x4 m. aluminium parasol for big terraces. 8 exchangeable ribs (20x35x1,5 mm). Crank-assisted opening system. Telescopic. With or without valance and with airvent.

Parasol aluminium laqué pour grande terrasse 4x4 m. 8 baleines interchangeables (20x35x1,5 mm). Ouverture assistée manivelle. Téléscopique. Avec ou sans volant et avec soufflet.



Nuevo tejido impermeable. 67% poliéster - 33% PVC. Compatible con todos los parasoles Rio con faldón.

Novo tecido impermeável. 67% poliéster - 33% PVC. Compatível com todos os guarda-sois Rio com bambinela.

New waterproof fabric. 67% polyester - 33% PVC. Compatible with all Rio parasols with valance.

Nouveau tissu imperméable. 67% polyester - 33% PVC. Compatible avec le parasol Rio avec volants.



EN343

Level 3. Highest level of rain protection.



# FORMENTERA



white



anthracite

## Tamaños / Tamanhos / Sizes / Tailles

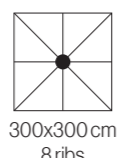
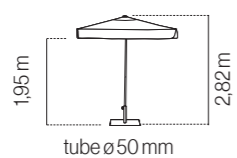

3x3

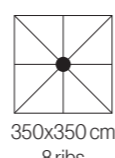
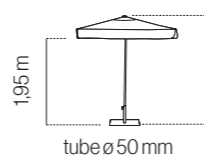
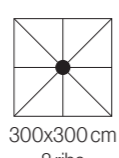
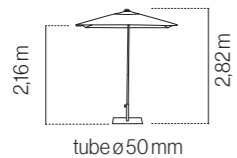

3,5x3,5

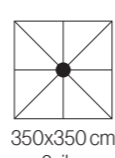
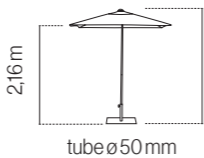

## Tejidos / Tecidos / Fabrics / Tissus

### Olefin



### Waterproof

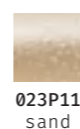

## Bases / Pieds (Pag. 186-187)

•KIT CROSS (3,5x3,5) •CUBE •FIX •FAST CLICK •BOND (3x3) •FLAT •CANTO

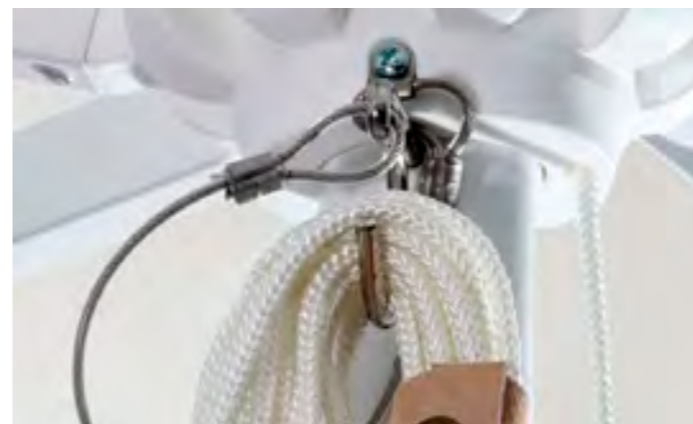

Parasol de aluminio lacado. 8 varillas (30x20 mm). Apertura por poleas. Sin volante y con fugavientos.  
 Guarda-sol em alumínio lacado. 8 varetas (30x20 mm). Abertura por roldanas. Sem bambinela e com fugaventos.  
 Lacquered aluminium parasol. 8 ribs (30x20 mm). Pulley opening system. Without valance and with airvent.  
 Parasol aluminium laqué. 8 baleines (30x20 mm). Ouverture par poulie. Sans volant et avec soufflet.



Nuevo tejido impermeable. 67% poliéster - 33% PVC. Compatible con todos los parasoles Formentera con faldón.  
 Novo tecido impermeável. 67% poliéster - 33% PVC. Compatível com todos os guarda-sois Formentera com bambinela.  
 New waterproof fabric. 67% polyester - 33% PVC. Compatible with all Formentera parasols with valance.  
 Nouveau tissu imperméable. 67% polyester - 33% PVC. Compatible avec tous les parasols Formentera avec volants.



EN343  
 Level 3. Highest level of rain protection.



## Referencias / Referências / References / Références



Color frame	3x3	3,5x3,5
white	SGA010C3000240P	SGA010C3500140P
anthracite	SGA010C3000540P	SGA010C3500340P
white	SGA010C3000220P	SGA010C3500120P
anthracite	SGA010C3000520P	SGA010C3500320P
white	SGAP11C3000242P	SGAP11C3500142P
anthracite	SGAP11C3000542P	SGAP11C3500342P



grey

Tamaños / Tamanhos / Sizes / Tailles

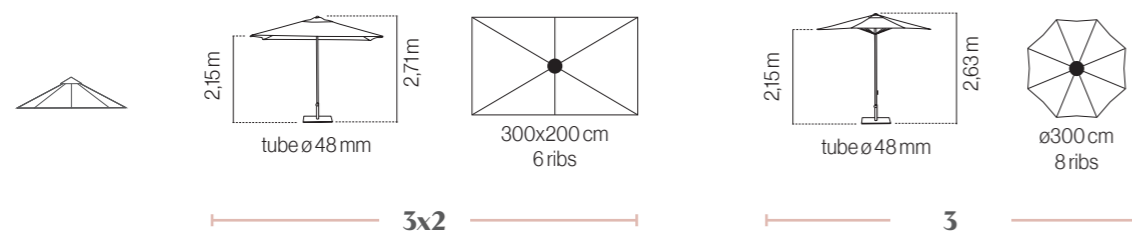

Tejidos / Tecidos / Fabrics / Tissus

Olefin



Bases / Pieds (Pag. 186-187)

- CUBE •FIX •FASTCLICK •ROUND •MOULD •BOND •FLAT •CANTO

Referencias / Referências / References / Références

	Color frame	3x2	3
	■ grey	SGA010H3000020P	SIA010030000820P



Parasol de aluminio lacado gris. 8 varillas (19x13 mm). Apertura por poleas. Sin volante y con fugavientos.  
 Guarda-sol em alumínio lacado cinza. 8 varetas (19x13 mm). Abertura por roldanas. Sem bambinela e com fugaventos.  
 Grey lacquered aluminium parasol. 8 ribs (19x13 mm). Pulley opening system. Without valance and with airvent.  
 Parasol aluminium laqué gris. 8 baleines (19x13 mm). Ouverture par poulie. Sans volant et avec soufflet.





Tamaños / Tamanhos / Sizes / Tailles

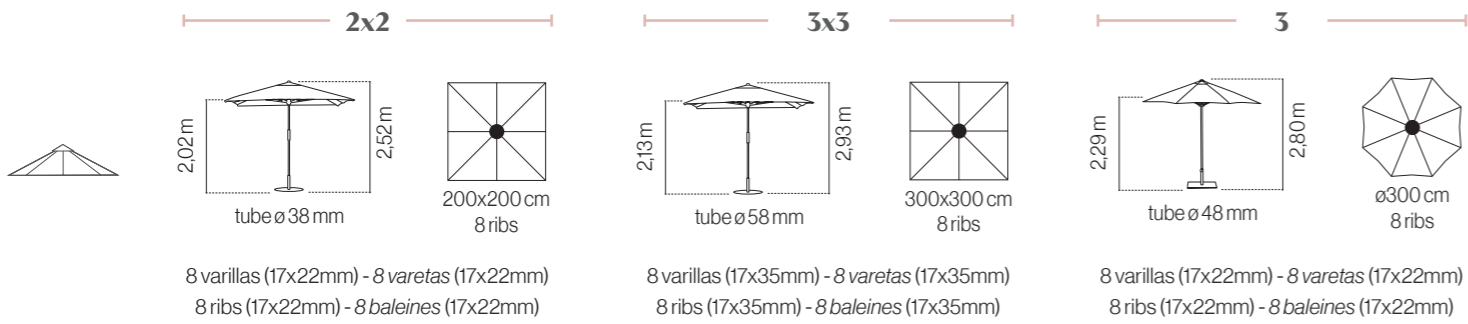

Tejidos / Tecidos / Fabrics / Tissus

Olefin



Bases / Pieds (Pag. 186-187)

•CUBE •FIX •FASTCLICK •ROUND •BOND •FLAT•CANTO

Referencias / Referências / References / Références

Color frame	2x2	3x3	3
wood	SPM010C2000220P	SGM010C3000220P	SIM01003000720P



Parasol de madera de eucalipto barnizada. 8 varillas. Apertura por poleas. Sin volante y con fugavientos. Madera procedentes de fuentes sostenibles. Certificado FSC.

Guarda-sol de madeira de eucalipto envernizada. 8 varetas. Abertura por roldanas. Sem bambinela e com fugaventos. Madeira proveniente de fontes reflorestadas. Certificado FSC.

Varnished eucalyptus wood parasol. 8 ribs. Pulley opening system. Without valance and with airvent. Wood from reforested sources. FSC certified.

Parasol bois d'eucalyptus verni. 8 baleines. Ouverture par poulie. Sans volant et avec soufflet. Bois provenant de sources reboisées. Certified FSC.





## MADEIRA 3

NEW

SIMO1003000750P

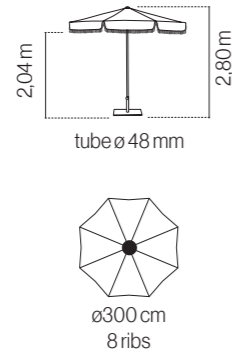

### Olefin

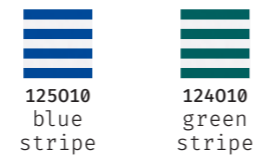

Parasol de madeira de eucalipto barnizada. 8 varillas (17x22mm). Apertura por poleas. Con volante, fleco y fugavientos. Madera procedente de fuentes sostenibles.

Guarda-sol de madeira de eucalipto envernizada. 8 varetas (17x22mm). Abertura por roldanas. Com bambinela, franjas e fugavientos. Madeira proveniente de fontes reflorestadas. Certificado FSC.

Varnished eucalyptus wood parasol. 8 ribs (17x22mm). Pulley opening system. With valance, fringes and airvent. Wood from reforested sources. FSC certified.

Parasol bois d'eucalyptus verni. 8 baleines (17x22mm). Ouverture par poulie. Avec volants, franges et soufflet. Bois provenant de sources robisées. Certified FSC.



### Bases / Pieds (Pag. 186-187)

- CUBE
- FIX
- FAST CLICK
- ROUND
- BOND
- FLAT
- CANTO

## FARO INOX 2x2

SPIO10C2000320P

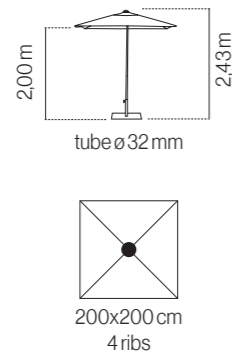

### Olefin



Parasol de INOX. 4 varillas de fibra de vidrio (12,5 mm). Apertura Push-Up. Sin volante y con fugavientos.

Guarda-sol em INOX. 4 varetas de fibra de vidro (12,5 mm). Abertura Push-Up. Sem bambinela e com fugavientos.

INOX parasol. 4 fiberglass ribs (12,5 mm). Push-Up opening system. Without valance and with airvent.

Parasol INOX. 4 baleines en fibre de verre (12,5 mm). Ouverture Push-Up. Sans volant et avec soufflet.



### Bases / Pieds (Pag. 186-187)

- ROUND
- FLAT
- FIT

## PALMA GREY 2,5

SIAO1002500000P

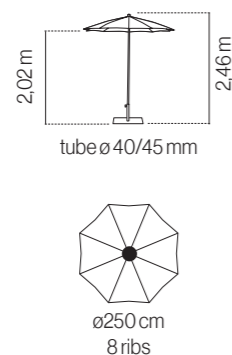

### Olefin



Parasol de aluminio. 8 varillas de fibra de vidrio (8 mm). Regulable en altura. Sin volante y sin fugavientos. Capito T extrarresistente.

Guarda-sol em aluminio. 8 varetas de fibra de vidro (8 mm). Regulável em altura. Sem bambinela e sem fugavientos. Tip T extraforte.

Aluminium parasol. 8 fiberglass ribs (8 mm). Adjustable height. Without valance and without airvent. Extrarresistant T tip.

Parasol aluminium. 8 baleines en fibre de verre (8 mm). Ajustable en hauteur. Sans volant et sans soufflet. Tip T extra forte.



### Bases / Pieds (Pag. 186-187)

- ROUND
- MOULD
- FLAT

## MENORCA 2,5

NEW

SIAO1002500006P

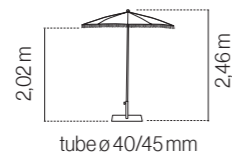

### Olefin



Parasol de aluminio. 8 varillas de fibra de vidrio (8 mm). Regulable en altura. Sin volante y sin fugavientos. Con flecos. Capito T extrarresistente.

*Guarda-sol em alumínio. 8 varetas de fibra de vidro (8 mm). Regulável em altura. Sem bambinela e sem fugavientos. Com franjas. Tip T extraforte.*

Aluminium parasol. 8 fiberglass ribs (8 mm). Adjustable height. Without valance and without airvent. Whit fringes. Extrarresistant T tip.

*Parasol aluminium. 8 baleines en fibre de verre (8 mm). Ajustable en hauteur. Sans volant et sans soufflet. Avec franges. Tip T extra forte.*



### Bases / Pieds (Pag.186-187)

- ROUND
- MOULD
- FLAT

## TENERIFE INOX 2

SPIO10D2005310P

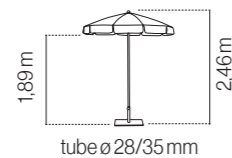

### Olefin

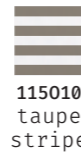
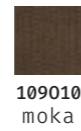
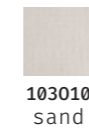
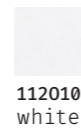

Parasol de INOX con inclinación. 10 varillas de fibra de vidrio (6 mm). Regulable en altura. Con volante y sin fugavientos. Capito T extrarresistente.

*Guarda-sol em INOX com inclinação. 10 varetas de fibra de vidro (6 mm). Regulável em altura. Com bambinela e sem fugavientos. Tip T extraforte.*

INOX parasol with tilt system. 10 fiberglass ribs (6 mm). Adjustable height. With valance and without airvent. Extrarresistant T tip.

*Parasol INOX avec inclinaison. 10 baleines en fibre de verre (6 mm). Ajustable en hauteur. Avec volants et sans soufflet. Tip T extra forte.*



INOX

### Bases / Pieds (Pag.186-187)

- ROUND
- MOULD
- FLAT
- FIT

## ONS SAND 2

SPA010D2000110T

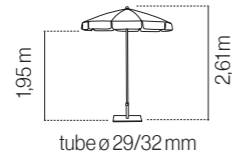

### Olefin

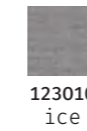
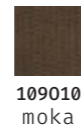
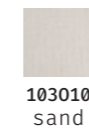
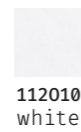

Parasol de aluminio lacado sand. 10 varillas de fibra de vidrio (6 mm). Regulable en altura. Con volante y sin fugavientos. Capito T extrarresistente.

*Guarda-sol em alumínio lacado sand. 10 varetas de fibra de vidro (6 mm). Regulável em altura. Com bambinela e sem fugavientos. Tip T extraforte.*

Sand lacquered aluminium parasol. 10 fiberglass ribs (6 mm). Adjustable height. With valance and without airvent. Extrarresistant T tip.

*Parasol aluminium laqué sand. 10 baleines en fibre de verre (6 mm). Ajustable en hauteur. Avec volants et sans soufflet. Tip T extra forte.*



### Bases / Pieds (Pag.186-187)

- ROUND
- FLAT
- FIT

NEW TOSCANA

NEW

SPA010D2000150T

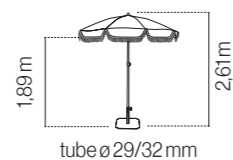

Olefin



Parasol de aluminio lacado sand. 10 varillas de fibra de vidrio (6 mm). Regulable en altura. Con flecos. Con volante y sin fugavientos. Capito T extrarresistente.

Guarda-sol em alumínio lacado sand. 10 varetas de fibra de vidro (6 mm). Regulável em altura. Com franjas. Com bambelina e sem fugavientos. Tip T extraforte.

Sand lacquered aluminium parasol. 10 fiberglass ribs (6 mm). Adjustable height. With fringes. With valance and without airvent. Extrarresistant T tip.

Parasol aluminium laqué sand. 10 baleines en fibre de verre (6 mm). Ajustable en hauteur. Avec franges et volants et sans soufflet. Tip T extra forte.



Bases / Pieds (Pag. 186-187)

- ROUND
- FLAT
- FIT

MANILA NATURAL 2

SPSZ02D2000001T

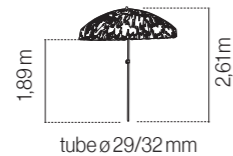

Parasol de acero imitación madera natural. 10 varillas de fibra de vidrio (6 mm). Regulable en altura. Con volante y sin fugavientos.

Guarda-sol em aço imitação madeira natural. 10 varetas de fibra de vidro (6 mm). Regulável em altura. Com bambelina e sem fugavientos.

Natural wood finishing steel parasol. 10 fiberglass ribs (6 mm). Adjustable height. With valance and without airvent.

Parasol acier finition bois naturel. 10 baleines en fibre de verre (6 mm). Ajustable en hauteur. Avec volants et sans soufflet.



Bases / Pieds (Pag. 186-187)

- ROUND
- FLAT
- FIT

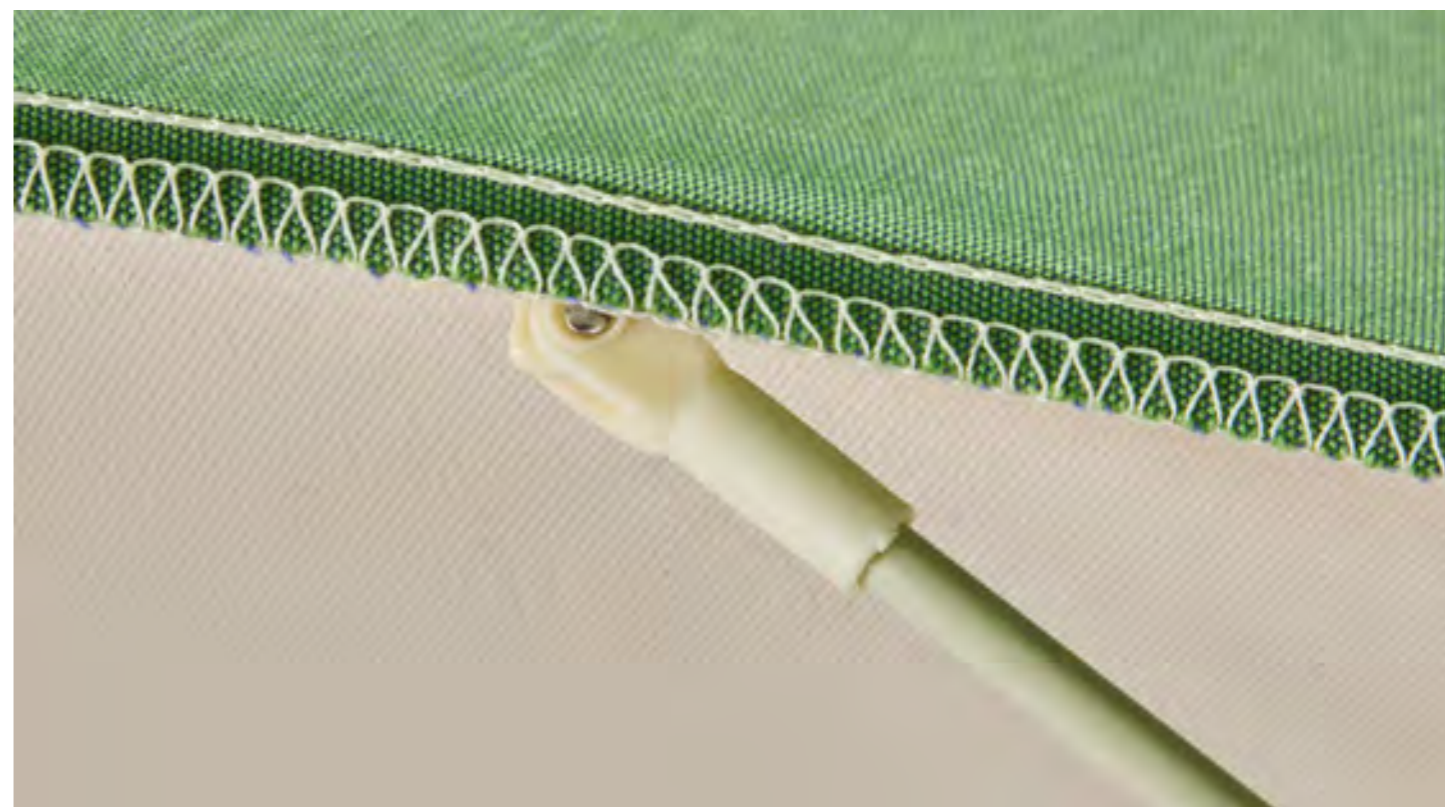

## FUNDA PARASOL - CAPA GUARDA-SOL - PARASOL COVER - COUVERTURE PARASOL



REF. 31P18C40000

RIO 400X4000

REF. 31P18C35000

FORMENTERA 350X350

FLEXO 300X300

REF. 31P18C30000

FORMENTERA 300X300

VIGO 300X300 - JAVA 300X300

REF. 31P18C25000

EOLO - VIGO - JAVA



POLY  
STER  
210g

WATER  
PROOF

+ INFO



## CANALON/CALEIRA/GUTTER/GOUTTIÈRES

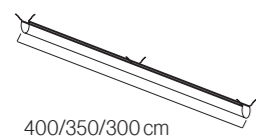

400/350/300cm

4x4 - IGAP00C40002

3,5x3,5 - IGAP00C35002

3x3 - IGAP00C30002



## SUNBRELLA

NEW

Tejido exclusivamente con fibras acrílicas teñidas en masa desde el núcleo del mismo hilo para garantizar su resistencia a la decoloración frente a los rayos UV. Acabado repelente al agua, resistente al moho y antimanchas que protege el tejido y hace que su mantenimiento sea muy sencillo.

Garantía de 5 años frente a la abrasión, la aparición de bolitas, la decoloración y la pérdida de tensión.

Cuenta con el Sello de Recomendación de la Skin Cancer Foundation (Fundación contra el Cáncer de la Piel) que garantiza la protección de la piel de los efectos nocivos de los rayos UV.

*Tecido exclusivamente com fibras acrílicas tingidas em massa a partir do núcleo do próprio fio para garantir a sua resistência à descoloração contra os raios UV. O acabamento repelente à água, ao mofo e às manchas protege o tecido e facilita a sua manutenção.*

*5 anos de garantia contra abrasão, borboto, descoloração e perda de tensão.*

*Com o Selo de Recomendação da "Skin Cancer Foundation" que garante a proteção da pele contra os efeitos nocivos dos raios UV.*

The fabric is exclusively crafted from acrylic fibers, dyed thoroughly within the core of the yarn to ensure resistance against UV-induced fading. Its water-repellent, mold-resistant, and stain-repellent finish safeguards the fabric, simplifying maintenance.

It is backed by a 5-year warranty against abrasion, pilling, fading, and tension loss.

Endorsed by the Skin Cancer Foundation Seal, guaranteeing protection against the harmful effects of UV rays on the skin.

*Tissu exclusivement en fibres acryliques teinté à la masse depuis son processus initial, afin de garantir une haute résistance à la décoloration due aux rayons UV. Toile déperlante, résistante aux moisissures, anti-tâches qui facilite ainsi son entretien.*

*Toile garantie 5 ans, contre l'abrasion, les bouloches, decolation et pertes de tension.*

*Certifiée est recommandée par la "SKIN CANCER FOUNDATION" qui garantit la protection de la peau aux effets nocifs des rayons UV.*

**sunbrella™**

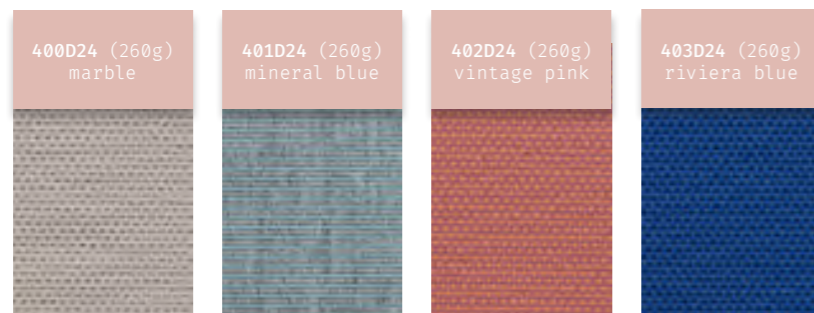

## DRALON

Tejido tintado en floca, solidez 5-6 sobre 8. En zonas de alta radiación y sobreexposición solar los colores oscuros pierden intensidad antes de los 6 meses, para estas zonas recomendamos colores claros como el blanco o el crudo.

*Tecido tingido em bando, solidez 5-6 de 8. Em áreas de alta radiação e sobre exposição ao sol, as cores escuras perdem intensidade antes dos 6 meses, para essas áreas recomendamos cores claras como branco ou crula piel de los efectos nocivos de los rayos UV.*

Fabric dyed in the fiber, color fastness rating 5-6 out of 8. In zones with excessive sunlight exposure, dark colors may lose intensity within less than 6 months. For such areas, we recommend light colors such as white or beige.

Tissu teint avec flochage, solidité 5-6 sur 8. Dans les zones de fort rayonnement et de surexposition solaire, les couleurs sombres perdent de leur intensité après 6 mois d'utilisation. Pour ces zones nous recommandons des couleurs claires, comme l'écreu ou le blanc.

**dralon®**  
a step ahead in acrylic fibers

## OLEFIN

Alta solidez de los colores a la radicación UV (7/8). Se trata de un tejido fabricado con hilo de polipropileno que ha sido tintado en masa, en su proceso inicial. Esto le otorga una gran resistencia a la luz solar ya que el color queda fijado en el hilo del tejido con mayor intensidad que en otros procesos. Dependiendo del color varía la durabilidad de la intensidad de los colores a la exposición solar.

Certificación UV standard 801 con la puntuación UPF 80, que garantiza la protección de la piel de los efectos nocivos de los rayos UV.

Repelente al agua - resistente a las manchas - 100% reciclable.

*Alta resistência das cores face à radiação UV. Ao ser um tecido fabricado com fio de polipropileno tingido em massa no seu processo inicial, esta característica confere-lhe uma maior resistência à luz solar o que se deve essencialmente ao facto de a cor permanecer fixa ao fio com maior intensidade do que em outros processos de pigmentação. A durabilidade da intensidade das cores, varia dependendo da cor e da exposição solar.*

*Certificação UV standard 801 com factor de proteção UPF 80, que garante a proteção da pele dos efeitos nocivos dos raios UV.*

*Repelente à água - anti-manchas - 100% reciclável.*

High resistance of colours to UV radiation (7/8). The fabric is made from polypropylene fabric mass-dyed during the initial process. This provides high resistance to sunlight because the colour is set in the thread of the fabric more intensely than in other processes. Depending on the color, the durability of color intensity varies when exposed to sunlight.

UV standard 801 certification rating UPF 80, that guarantees skin protection against nocive effects of UV rays on the skin.

Water repellent - stain resistance - 100% recyclable.

*Haute résistance des couleurs face à la radiation solaire. Il s'agit ici d'une toile fabriquée à partir d'un fil en polypropylène qui a été teinté en masse, depuis son processus initial. Ceci lui confère une haute résistance à la lumière solaire, étant donné que la teinte reste fixée sur le fil avec une plus grande intensité en comparaison avec d'autres processus de pigmentation. Selon la couleur choisie, la durabilité de l'intensité de celle-ci varie en fonction de l'exposition au soleil.*

*Certification UV standard 801 avec un facteur de protection UPF 80, qui garantie une protection de la peau face aux effets nocifs des rayons UV.*

*Deperlante - résistante toile aux tâches - 100% recyclable.*



SOLUTION DYED - COLOUR FASTNESS: 7-8/8 - 100% RECYCLABLE

Disponemos de un tejido de poliéster 100% tintado en masa para pedidos con logotipo.

*Temos um tecido 100% poliéster tingido em massa para pedidos com logotipo.*

We have a 100% mass-dyed polyester fabric for orders with a logo.

*Nous avons un tissu 100% polyester teint dans la masse pour les commandes avec logo.*

\* Solidez 7-no recomendado para zonas de alta radiación solar. Solidez 7-Não recomendado para áreas de alta exposição solar. Color fastness rating 7-not recommended for areas with excessive sunlight exposure. Sa solidité est de 7-Déconseillé pour des zones à fort rayonnement solaire.

## SLAB (cemento/polipropileno - cimento/polipropileno - concrete/polypropylene - iment/polypropylène)

Flexo



## KIT FLEXO (hierro/cemento/polipropileno - ferro/cimento/polipropileno - iron/concrete/polypropylene - fer/ciment/polypropylène)

Flexo



## KIT CROSS (hierro/cemento - ferro/cimento - iron/concrete - fer/ciment)

Rio



## CUBE (cemento - cimento - concrete - ciment)

Eolo  
Formentera  
Vigo  
Java 2X2  
Java 3  
Madeira



## FIX (hierro - ferro - iron - fer)

Eolo  
Rio  
Formentera  
Vigo  
Java 3  
Madeira



## FAST CLICK (inox)

Eolo  
Rio  
Formentera  
Vigo  
Java 3  
Madeira



## ROUND (cemento - cimento - concrete - ciment)\*

Eolo  
Vigo  
Java 2x2  
Java 3  
Madeira  
Faro  
Palma  
Menorca  
Tenerife  
Ons  
New toscana  
Manila

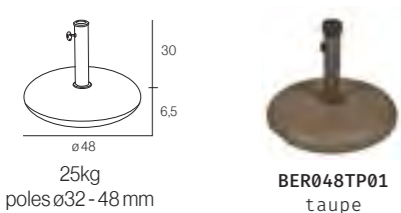

## MOULD (cemento/polipropileno - cimento/polipropileno - concrete/polypropylene - ciment/polypropylène)\*

Eolo  
Vigo  
Palma  
Menorca  
Tenerife

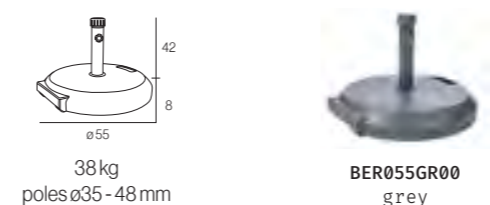

## BOND (cemento/polipropileno - cimento/polipropileno - concrete/polypropylene - ciment/polypropylène)

Eolo  
Formentera 3x3  
Vigo  
Java 3  
Madeira



Base de cemento con carcasa de polipropileno, tubo de acero lacado con tratamiento antióxido (cataforesis), tornillería de acero zincado y ruedas.  
Base de cemento com revestimento em polipropileno, tubo em aço lacado com tratamento anti-ferrugem (cataforesis), parafusos em aço zincado e com rodas.  
Cement base with polypropylene casing, anti-rust treated (cataphoresis) coated steel tubing, castors and stainless steel screws.  
Base en ciment revêtit de polypropylène, tube en acier laqué avec traitement antirouille (cataphorèse), vis et roues en acier zingué.

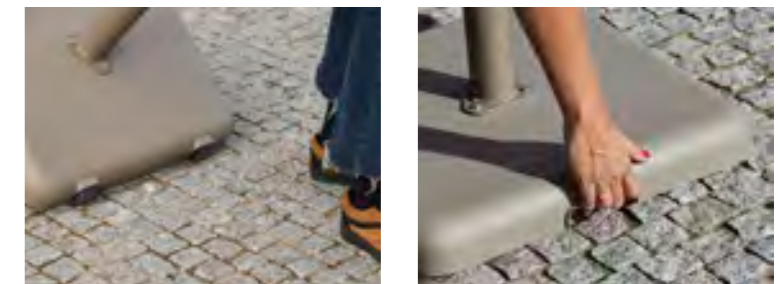

## FLAT (hierro - ferro - iron - fer)

Eolo  
Vigo  
Java  
Madeira  
Faro  
Palma  
Menorca  
Tenerife  
Ons  
Toscana  
Manila



## CANTO (hierro - ferro - iron - fer)

Eolo  
Formentera  
Vigo  
Java 3  
Java 3X3  
Madeira



Cantonerías de acero inoxidable para separar la chapa del suelo.  
Protectores de aço inoxidável para separar a chapa do chão.  
Stainless steel corner pieces to separate sheet metal from the floor.  
Extrémities en acier inoxydable pour séparer la tôle du sol.



MO-SIE41K (kit 4 U)  
Rueda con freno - roda com travão - wheels with brake - roue avec frein.

## FIT (hierro - ferro - iron - fer)

Faro  
Tenerife  
Ons  
Toscana  
Manila



## POLYPROPYLENE

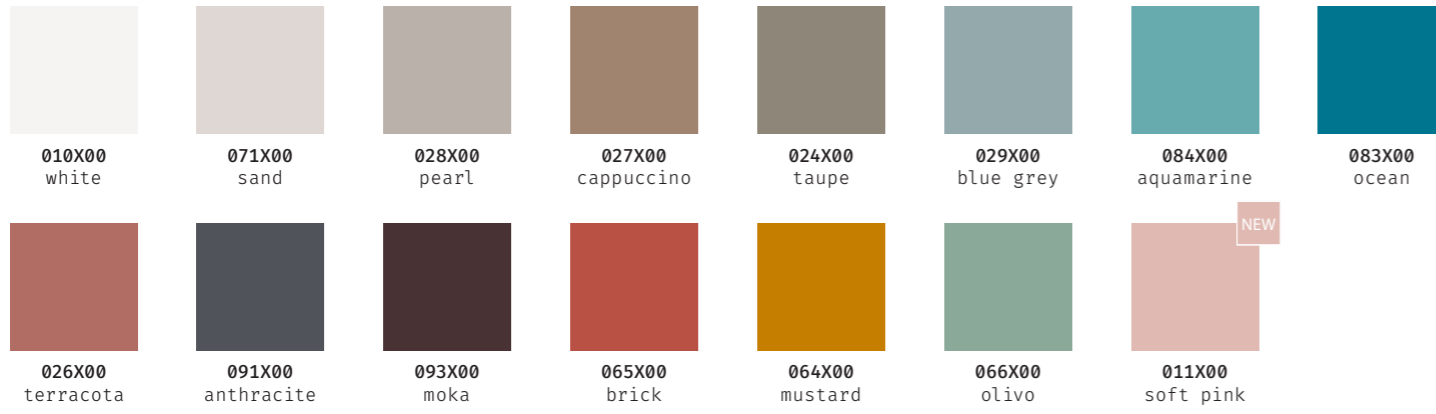

## COMPACT



## METAL



## OLEFIN

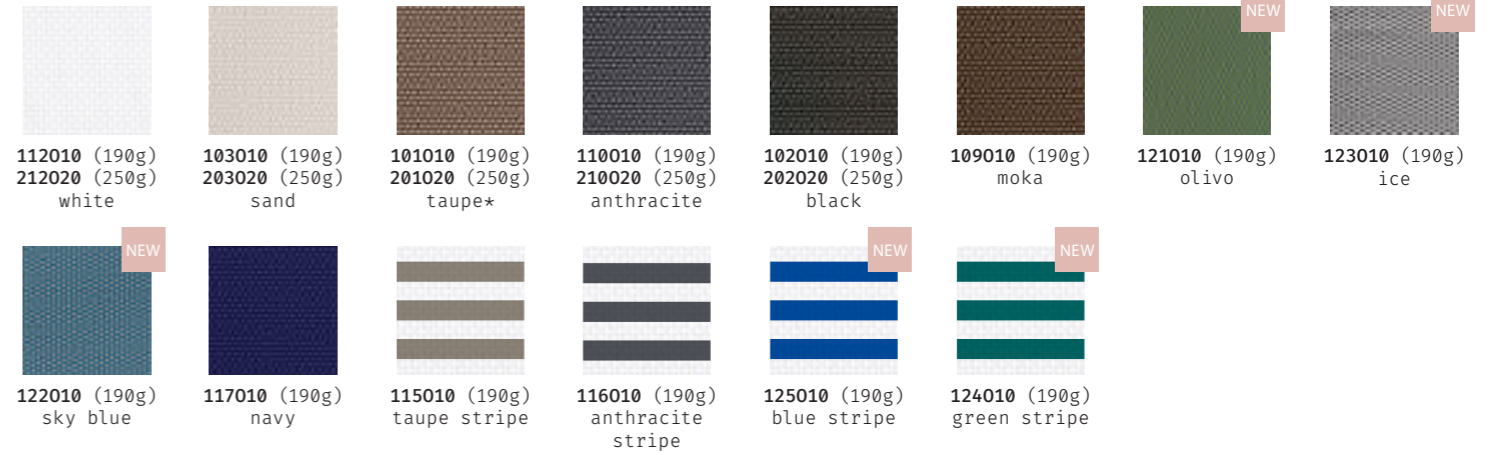

## SUMBRELLA

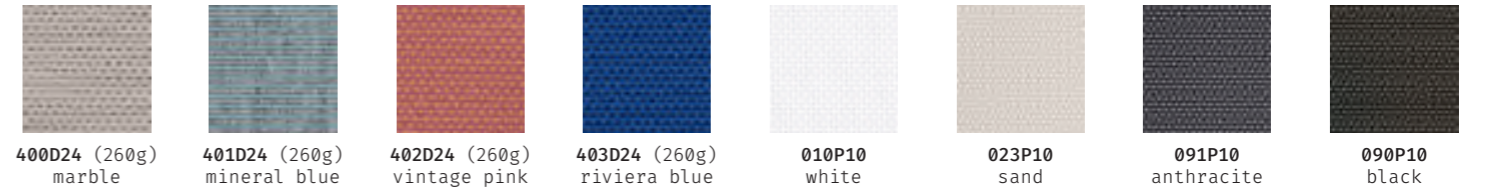

## POLYESTER 100% - LOGO

## PHIFERTEX®

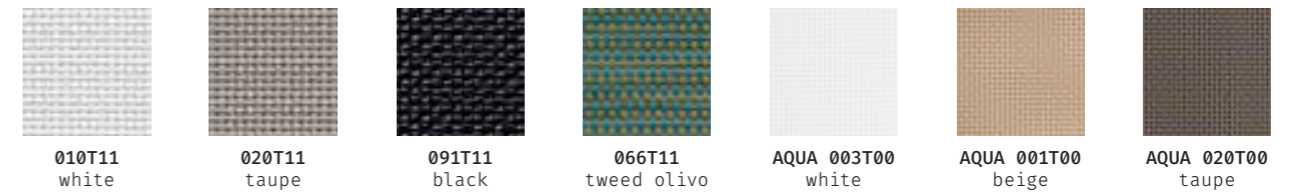

## AQUA

## DRALON® (Ibiza)



## PAD

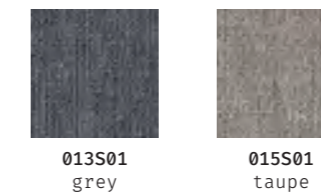

## NAUTIC

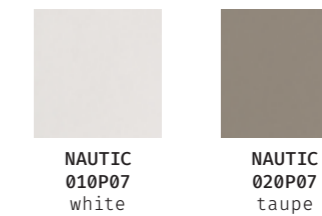

## WATERPROOF

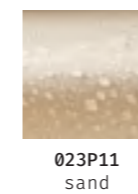

\* Solidez 7-no recomendado para zonas de alta radiación solar. Solidez 7-Não recomendado para áreas de alta radiação solar. Color fastness rating 7-not recommended for areas with excessive sunlight exposure. Sa solidité est de 7-Déconseillé pour des zones à fort rayonnement solaire.



Contact us:

SPAIN

info@ezpeleta.com  
tel. +34 986 293 922

PORTUGAL

ezpeleta.portugal@ezpeleta.com  
tel. +351 251 79 62 55

FRANCE

france@ezpeleta.com  
tel. +34 986 293 922

MEXICO

ezpeleta.mexico@ezpeleta.com  
tel. +52 55 5520 2919  
tel. +52 55 5520 5909

EXPORT (other countries)

export@ezpeleta.com  
tel. +34 986 293 922

Ezpeleta se reserva el derecho a realizar modificaciones técnicas en los productos de este catálogo. / A Ezpeleta reserva-se o direito de realizar qualquer alteração técnica nos produtos descritos neste catálogo. / Ezpeleta reserves the right to change the technical characteristics and specifications of the product in this catalog. / Ezpeleta se réserve le droit de réaliser des modifications techniques sur les produits décrits sur ce catalogue.

Todas las medidas y colores indicados en este catálogo son aproximados. / Todas as medidas e cores indicadas neste catálogo são aproximadas. / All dimensions and colours indicated in this catalogue are approximate. / Toutes les dimensions et couleurs indiquées dans ce catalogue sont approximées.

EMPRESA ASOCIADA 



# ezpeleta<sup>e</sup>

Follow us / Síguenos:



EZPELETA GROUP  
SINCE 1935

